



AUSTRALIAN
GLASS & WINDOW
ASSOCIATION

AUSTRALIAN GLASS AND WINDOW ASSOCIATION GUIDE SERIES

A GUIDE TO RESIDENTIAL INSTALLATION



AN INDUSTRY GUIDE TO THE
CORRECT INSTALLATION OF
WINDOWS AND DOORS

VERSION 4
JULY 2020

CONTENTS

| | | | |
|---|-----------|--|-----------|
| FOREWORD | 3 | HOW TO USE THIS GUIDE | 15 |
| AUSTRALIAN GLASS AND WINDOW ASSOCIATION | 3 | MATERIALS KEY | 15 |
| INDUSTRY GUIDE OBJECTIVE | 3 | CAVITY VENEER CONSTRUCTION | 16 |
| ACKNOWLEDGEMENT | 3 | ALUMINIUM WINDOW INSTALLATION | 16 |
| DISCLAIMER | 3 | ALUMINIUM SLIDING DOOR INSTALLATION | 18 |
| | 3 | UPVC WINDOW INSTALLATION | 20 |
| RESPONSIBILITIES | 4 | UPVC SLIDING DOOR INSTALLATION | 22 |
| THE NATIONAL CONSTRUCTION CODE INSTALLATION | 4 | TIMBER WINDOW INSTALLATION | 24 |
| IDENTIFICATION OF SITE RATINGS | 4 | TIMBER SLIDING DOOR INSTALLATION | 26 |
| | 4 | CAVITY MASONRY CONSTRUCTION | 28 |
| CARE & MAINTENANCE | 6 | ALUMINIUM WINDOW INSTALLATION | 28 |
| PRE-INSTALLATION CARE | 6 | ALUMINIUM SLIDING DOOR INSTALLATION | 30 |
| POST-INSTALLATION CARE | 6 | UPVC WINDOW INSTALLATION | 32 |
| Door Tracks and Sills | 6 | UPVC SLIDING DOOR INSTALLATION | 34 |
| General Soiling | 7 | TIMBER WINDOW INSTALLATION | 36 |
| Acid Spills | 7 | TIMBER SLIDING DOOR INSTALLATION | 38 |
| Glass | 7 | SINGLE SKIN VENEER CONSTRUCTION | 40 |
| Hardware | 7 | ALUMINIUM WINDOW INSTALLATION | 40 |
| Use of Hose | 8 | ALUMINIUM SLIDING DOOR INSTALLATION | 42 |
| | 8 | UPVC WINDOW INSTALLATION | 44 |
| FLASHING | 9 | UPVC SLIDING DOOR INSTALLATION | 46 |
| SILL FLASHING | 9 | TIMBER WINDOW INSTALLATION | 48 |
| SPECIAL CARE | 9 | TIMBER SLIDING DOOR INSTALLATION | 50 |
| JAMB FLASHING | 10 | SOLID MASONRY CONSTRUCTION | 52 |
| HEAD FLASHING | 10 | ALUMINIUM WINDOW INSTALLATION | 52 |
| | 10 | ALUMINIUM SLIDING DOOR INSTALLATION | 54 |
| INSTALLATION | 12 | UPVC WINDOW INSTALLATION | 56 |
| COMMON INSTALLATION PROBLEMS | 12 | UPVC SLIDING DOOR INSTALLATION | 58 |
| CORRECT INSTALLATION OF FRAMES | 12 | TIMBER WINDOW INSTALLATION | 60 |
| | 12 | TIMBER SLIDING DOOR INSTALLATION | 62 |
| CONSTRUCTION TYPES | 14 | | |
| TYPE A: CAVITY VENEER | 14 | | |
| TYPE B: CAVITY MASONRY | 14 | | |
| TYPE C: SINGLE SKIN VENEER | 14 | | |
| TYPE D: SOLID MASONRY | 14 | | |

FOREWORD

As part of its commitment to raising the built performance standard of glass, windows and doors in Australian Glass and Window Association (AGWA) is pleased to provide this Industry Guide to the correct installation of windows and doors.

AUSTRALIAN GLASS AND WINDOW ASSOCIATION

AGWA is the peak association representing over 1000 member companies covering window manufacturers, glass manufacturers, glass processors, merchants, glaziers and suppliers of supporting machinery, services and materials. We endorse compliant, sustainable and fit-for-purpose products and provide services to members that support their efforts to operate successfully.

AGWA delivers access to expertise for all members and stakeholders in key areas including:

- Technical support
- Training
- Accreditation
- Communication
- Workplace Health and Safety
- Marketing
- Events

INDUSTRY GUIDE OBJECTIVE

This industry guide to the installation of windows and doors sets out to provide the basic handling and installation instructions for windows and doors in residential buildings. By providing this resource as an instruction guide it is hoped that windows and doors supplied to residential buildings remain valuable and easy to install and maintain during the construction process.

This guide is designed to be used in conjunction with the AGWA Industry Guide to Fixing.

ACKNOWLEDGEMENT

The AGWA gratefully acknowledges those member companies whose contribution of materials and continued support to the AGWA Technical Committee and its sub committees have made this guide possible.

DISCLAIMER

This guide has been developed to provide general guidance, awareness and education to AGWA members, stakeholder groups and consumers. It should not be viewed as a definitive guide. While every effort has been made to ensure the information is accurate, the AGWA expressly disclaims all and any liability to any person for anything done in reliance on this publication. No responsibility is accepted by the AGWA for any mistakes, errors or omissions in this publication.

RESPONSIBILITIES

THE NATIONAL CONSTRUCTION CODE

The National Construction Code (NCC) is produced and maintained by the Australian Building Codes Board (ABCB) on behalf of the Australian Government and each State and Territory Government.

Under the NCC, the Building Code of Australia (BCA) is a uniform set of technical provisions for the design and construction of buildings and other structures throughout Australia. It allows for variations in climate and geological or geographic conditions.

Under Part 3.0, Section 3.6.0 of Volume 2 of the BCA, performance requirements (P2.1 and P2.2.2) are satisfied if windows are designed and constructed in accordance with AS 2047. For glazed assemblies not covered by AS 2047 compliance to AS 1288 is required.

Under Section B and Section F of Volume 1 of the BCA, performance requirements are satisfied if windows are designed and constructed in accordance with AS 2047. For glazed assemblies not covered by AS 2047, compliance to AS 1288 is required.

AS 2047 Windows and External Glazed Doors in Buildings

AS 1288 Glass in Buildings: Selection and Installation

INSTALLATION

At all times manufacturer's installation instructions will be the predominant procedure for the installation of proprietary windows. Installers should ensure that manufacturer's instructions are adopted.

The practices outlined in this guide are not intended to supersede manufacturer's

instructions but provide basic and generic guidelines in the absence of such.

Approved personal protective equipment (PPE) should be worn at all times when handling windows.

Special consideration needs to be given to window and door systems designed specifically for acoustics and energy efficiency. Reference must be made to the building designer or installer for installation details.

IDENTIFICATION OF SITE RATINGS

Extract from Appendix C AS 2047:2014

Nomination of window ratings or design wind pressures for each window and door assembly should be as follows:

- (a) For housing, the purchaser should nominate —
 - (i) the window rating;
 - (ii) the window exposure classification; and
 - (iii) whether the window is a corner window when ordering the window assemblies.
- (b) For other residential buildings, the purchaser should nominate the design wind pressures when ordering the window assemblies.
- (c) For commercial buildings, the purchaser should nominate the design wind pressures for the window assemblies when ordering the windows.
- (d) The manufacturer of the window assemblies should verify the window assemblies meet the window rating or design wind pressures as provided by the purchaser.

RESPONSIBILITIES

Extract from AS 2047:2014 – Section 8

8.1 GENERAL

Window assemblies for housing shall be labelled in accordance with Clause 8.2. Timber windows for housing and window assemblies for other than housing shall be labelled in accordance with Clause 8.2, or a certificate in accordance with Clause 8.3 shall be provided.

Note: Where windows for housing are supplied as incomplete assemblies, a certificate and a label giving manufacturer's identification marks, window rating and water penetration resistance should be provided with the window.

8.2 LABELLING

The label shall be so positioned that the window can be identified when viewed in situ.

Each window shall have the following information marked anywhere on the window assembly, except on the glazing (the application of rating labels on fixed glazed timber windows is permitted):

- (a) The manufacturer's identification mark.
- (b) The Serviceability Limit State wind pressure.
- (c) The Ultimate Limit State wind pressure.
- (d) The water penetration resistance.

8.3 CERTIFICATE

A certificate indicating the manufacturer's identification, the Serviceability Limit State wind pressure, the Ultimate Limit State wind pressure and the water penetration resistance shall be provided with window assemblies.

When making a statement of compliance with this Australian Standard on a product, packaging or promotional material related to

that product, it shall be ensured that such compliance is capable of being verified.

When making a statement of compliance with this Australian Standard on a variation to a tested sample, it shall be ensured that such compliance is capable of being verified.

Figure 1 Performance Label



Figure 2 Compliance Certificate

COMPLIANCE CERTIFICATE

is a participating member of the **AWA Accreditation Program**, provides a **6 year Guarantee** against faulty workmanship and materials (see to Manufacturer's Warranty), is committed to the **Industry Code of Conduct** and has met the requirements of the annual **AWA Compliance Audit**.

The manufacturer certifies that the windows and doors supplied to:

Delivery address: _____

Delivered on: _____

have been manufactured to comply with the Australian Window Standard AS 2047 and Glass Standard AS 1288 including human impact requirements as specified in the order. The windows and doors have been manufactured to comply with NCC energy efficiency and bushfire requirements as specified by the purchaser.

The windows have been manufactured to comply with:

| Housing | | | Other Construction | | |
|---------|--------|--------|--|--------|--------|
| SLS Pa | ULS Pa | WPR Pa | SLS Pa | ULS Pa | WPR Pa |
| N1 400 | 600 | 150 | C1 600 | 1800 | 150 |
| N2 400 | 900 | 150 | C2 800 | 2700 | 200 |
| N3 600 | 1400 | 150 | C3 1200 | 4000 | 300 |
| N4 900 | 2000 | 200 | C4 1600 | 5300 | 450 |
| N5 1200 | 3000 | 300 | Note: For corner windows, the next highest rating pressure applies. | | |
| N6 1600 | 4000 | 450 | | | |

Energy Performance Ratings, AFRC Results: U Value, U _____
Solar Heat Gain Co efficient, SHGC, _____
Refer to attached schedule

Bushfire Rating: BAL 12.5 _____ BAL 19 _____ BAL 29 _____
BAL 40 _____ BAL F2 _____ Not Required/Specified

Methodology: Tested (AS 1500.8.1) _____ Tested (AS 1500.8.2) _____ Prescriptive (AS 3059) _____

Fall Prevention: Windows Restricted to max. 125 mm _____ Fall Prevention Screens _____
Not Required _____ Item Numbers _____

Signed: _____ Date: _____
Window Company

The builder/installer certifies that the windows and doors supplied have been installed correctly in accordance with the requirements of the National Construction Code and the human impact glass located in the correct openings.

Signed: _____ Date: _____
Builder/Installer

The inspection services of the AWA are accredited. Inspection Agency Number _____

CARE & MAINTENANCE

PRE-INSTALLATION CARE

Windows and doors should be stored in a clean, dry area away from cement, lime, paint, acid etc. and must be protected from building materials and loose debris such as wet plaster, mortar, paint and welding splatter.

- Store in a dry location, under cover where possible, to protect against damage.
- Carry windows in the vertical position with sashes locked.
- Do not rack frames out of square.
- Prevent exposure to moisture particularly pooling and ponding.
- Do not remove any bands (if fitted) from double hung windows until after installation.
- Do not remove corner bracing (if fitted) until after installation.
- Do not remove flashing elements (if fitted).

Handle and stack frames carefully on site. Stand them upright on their sills (bottom of the window as installed), raised off the ground on pieces of timber or bricks. Stand them against a flat, vertical surface such as a shed and tie firmly in position, as in Figure 3.

Do not lean windows against a tree or post as they can be subject to permanent damage until installed into the building envelope. If the site is bare, lay frames flat on top of each other with weight evenly distributed to avoid buckling and distortion, as shown in Figure 4.

POST-INSTALLATION CARE

Door Tracks and Sills

Door tracks and window sills should be protected from planks, scaffolding and barrows, as shown in Figure 5.

Figure 3 Stacking Windows Onsite

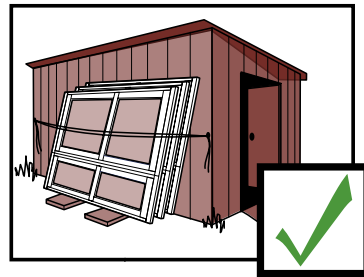
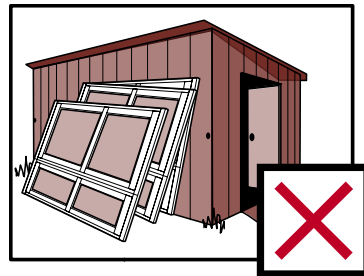
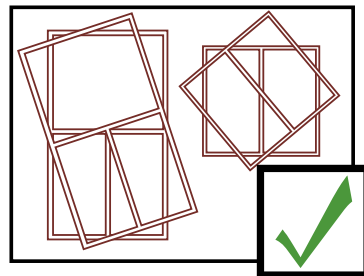
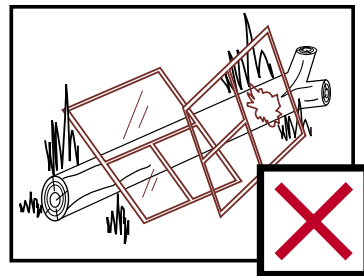

Figure 4 Flat Onsite Storage



CARE & MAINTENANCE

Figure 5 Door Tracks and Sills

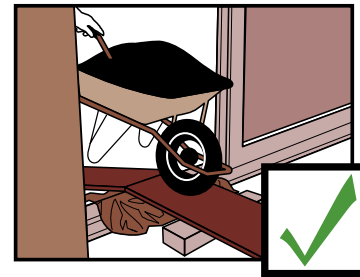
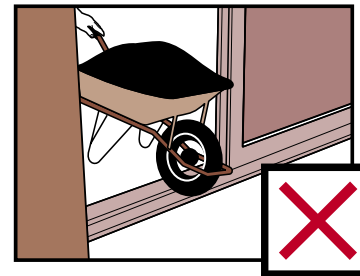
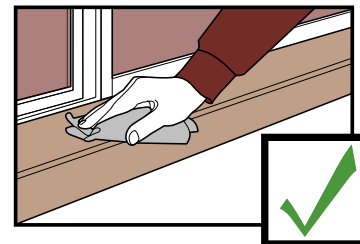
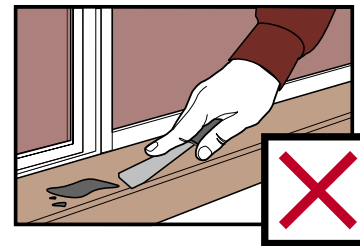

Figure 6 Soiling



General Soiling

If removal of debris is delayed and scraping becomes necessary the finish may be damaged. Remove cement, mortar and other droppings immediately, using ample clean water and a sponge or rag to avoid permanent staining of finished surfaces, as in Figure 6.

Acid Spills

Acid used for cleaning brickwork MUST be prevented from making contact with powdercoated or anodised aluminium windows and door surfaces. If any acid or similar corrosive material does come into contact with window or door surfaces those areas must be washed IMMEDIATELY with large quantities of clean water.

Glass

To clean glass, simply wipe over the surface with a few drops of methylated spirits on a damp cloth and then polish the surface dry with a lint free cloth. Ensure that all cleaning cloths are free of any abrasive substances.

Proprietary glass cleaners are not recommended as some can cause damage to the silver backing on mirrors and the interlayer in laminated glass. Avoid causing extreme temperature changes as this may lead to thermal fracture of the glass (ie. do not direct hot or cold water onto glass).

Hardware

Regular maintenance is required for all hardware, even stainless steel, as they are moving parts. In most environments maintenance is recommended every six (6) months and every three (3) months in marine and industrial environments.

CARE & MAINTENANCE

Exposed surfaces should first be wiped down with warm soapy water and a soft rag, and then rinsed clean before applying preventative.

Hangers, pivots and brackets should be given a light spray of a corrosion preventative (such as CRC Marine 66, Innox or WD40) followed by a light wipe with a dry cloth to remove excess.

Visible surfaces of hinges should be wiped down with warm soapy water on a soft rag and then rinsed off by wiping with a clean damp rag. Application of a thin film of light machine oil or one of the corrosion preventative sprays mentioned above will help to maintain the original lustre of the metal finish.

Be careful not to get these compounds on timberwork or anodised surfaces as they may cause staining.

Drop bolts should be sprayed with a lubricant such as those mentioned above at the sliding pin inside the bolt and to the lock cylinder. A tube attached to the nozzle will help to concentrate the spray where you want it to go.

Use of Hose

If using a hose or similar apparatus to clean windows and/or doors ensure the hose nozzle/jet fitting is set to a fine spray as shown in the diagram. At NO time should a window or door be hit with a full force of a hose, nozzle/jet setting as this may damage window seals and adversely affect air infiltration and water penetration performance. Figure 7.

Figure 7 Use of Hose

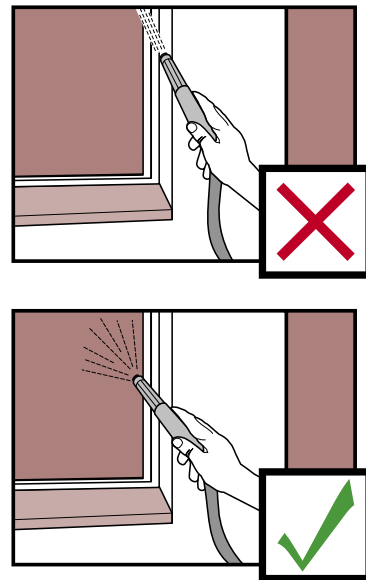

FLASHING

Flashing is essential to achieve proper weatherproofing of any wall openings, particularly around windows and doors. It is the builder or installers responsibility to ensure that windows and doors are installed in such a way that water does not penetrate from the outer skin to the inner skin of the building envelope. The extent of the flashing required depends on local weather conditions, the exposure of the window to the elements, the type of construction and other design requirements. For further information please refer to the relevant sections of the NCC.

There are three types of flashing: Sill, Jamb and Head. Flashing must be installed from bottom to top, in the following order, so that each layer overlaps the one below:

1. Sill flashing
2. Jamb Flashing
3. Head Flashing

The sarking above the window overlaps the head flashing. Overlap is vital to ensure that, at each transition, water is directed onto the element below.

Drainage must be provided below the window or door, so that any water captured has the ability to escape to the outside of the wall.

SILL FLASHING

Sill flashing must be installed to prevent water wetting the inner skin and entering the cavity under the window or door. Sill flashing also collects run off from the jamb flashing and directs it outside the building envelope.

- Must project a minimum of 150 mm both sides past the opening.
- Must be made of approved materials and comply with AS/NZS 2904.

- Must be provided with weepholes to let the water out. Maximum weephole spacing is 1200 mm from centres.
- In cavity construction:
 - Must be smooth and not sag into cavity where it could collect water.
 - Must not extend more than half the width of the outside brick skin.

SPECIAL CARE

Special care is required on windows with undersill drainage used in a non cavity situation such as single skin block work.

Where a subsill is used stop ends must be fitted and sealed.

Figure 8 Window Sill Flashing

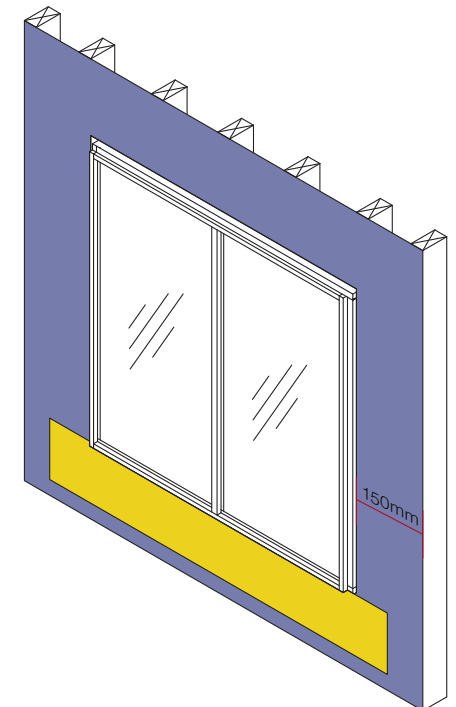

FLASHING

JAMB FLASHING

Jamb flashing is required in high wind locations to ensure that water which enters between the jamb and the outer skin is drained into the sill flashing.

- Where jamb flashing overlaps sill flashing, the overlap should extend the full depth of the sill flashing.
- Must extend the full depth of the sill flashing and project vertically a minimum of 150 mm above the opening.
- Must project horizontally a minimum of 150 mm both sides past the opening.
- Must be made of approved materials and comply with AS/NZS 2904.

Figure 9 Jamb Flashing

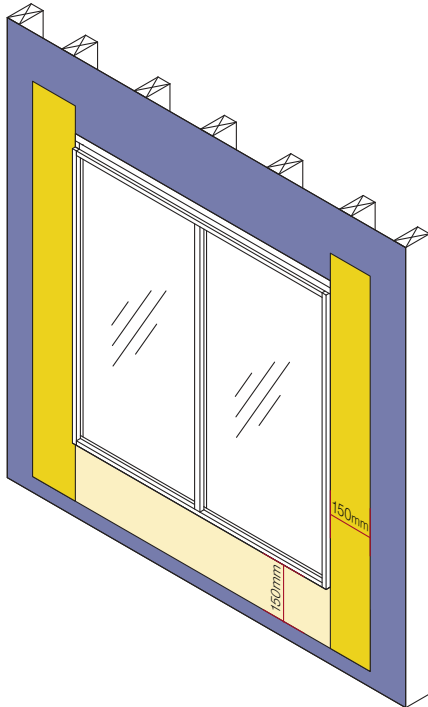

HEAD FLASHING

Head flashing must be installed to stop water wetting the inner skin by bridging across the window or door head.

- Must be installed above any wall penetrations not specifically designed to stop water reaching the inner skin (for example, exhaust fans and ventilation ducts).
- Must project horizontally a minimum of 150 mm both sides past the opening.
- Must project vertically a minimum of 150 mm above the opening.
- Must be made of approved materials and comply with AS/NZS 2904.

Figure 10 Head Flashing

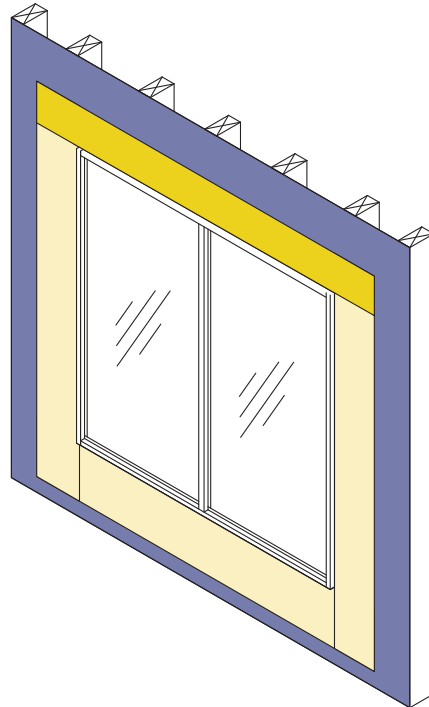

FLASHING

- Must be provided with weepholes to let the water out. Maximum weephole spacing is 1200 mm from centres.
- In cavity masonry construction, head flashing must be built into the inner skin a minimum of 30 mm.

INSTALLATION

COMMON INSTALLATION PROBLEMS

Installation problems are the prime cause of leaks in window assemblies. Contributing factors include omission or incorrect fitting of flashing, smothered or missing weepholes, or the loss of continuity in the water barrier.

The severity of wind exposure is the most important factor in the specification and installation of windows and doors. Components and installation practices acceptable in sheltered situations may quickly fail when exposed to the full force of the wind and rain.

CORRECT INSTALLATION OF FRAMES

1. Fit flashing to window surround as required.
2. Measure the frame opening to ensure that there is sufficient room for the product and additional packing.

Stud Opening

Height = O/A reveal size + adequate clearance

Width = O/A reveal size + adequate clearance

Clearance dimensions vary between manufacturer's products. For adequate clearance, refer to instructions.

3. Frame must be packed plumb, square and not twisted between the openings. Ensure the sill is fully supported. Failure to do so may result in sill roll on sliding windows.

Sills on all windows and doors must be straight and level and should be packed and secured.

To ensure the satisfactory long term performance of sliding doors, the sill should be fully supported. Where the sill projects during construction the sill should be fully supported.

4. Keep sashes closed whilst installing frames.
5. Secure frames with a fixing of a gauge and spacing appropriate for the wind load.

In brick veneer constructions, aluminium frames should be secured by nailing or screwing through reveal into stud work.

Timber windows should be secured by back nailing through stud, not face of frame stud. If it is not possible to backnail, wedges should be installed between the window and the building frame to prevent opening of the frame joints when nailing is carried out.

In cavity brick construction use galvanized building lugs located at 450 mm maximum centres.

6. Sill/head bricks should be at least 10 mm clear of window frame to allow settlement in brick veneer construction.
7. Do not permit weight of eaves or arch bars to bear on any window or door frame. **Windows and doors are not load bearing.**

INSTALLATION

Figure 11 Installation Summary

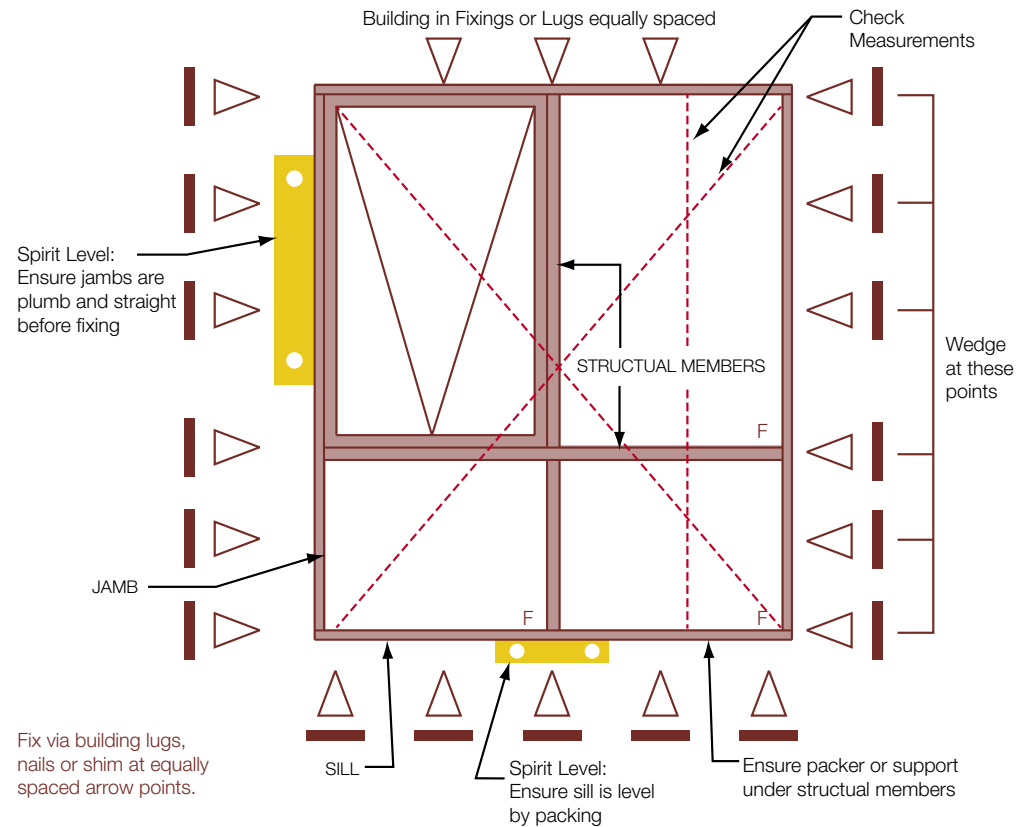

8. Do not stand on the windows or doors, or use them as a support for scaffolding, or slide material through the frame. It is important to prevent any damage to windows and doors during construction.
9. Remove cement mortar and plaster droppings from windows immediately, taking care to avoid scratching glass and, or frames, as permanent damage can result. Immediately wash off with water before material sets.

CONSTRUCTION TYPES

There are many different forms of construction in use throughout Australia. Most commonly, houses are built using either timber or steel frames with a variety of external cladding finishes, brick veneer or double brick construction. Larger building such as residential apartment blocks and commercial buildings are typically constructed using either one or a combination of construction types such as filled concrete blockwork, tilt slab or slab on pier methods.

Though there a wide variety of construction techniques, these can broadly be categorised into four types:

| | Veneer | Masonry |
|-------------|--------|---------|
| Cavity | A | B |
| Single Skin | C | D |

TYPE A: CAVITY VENEER CONSTRUCTION

The most common form of type A construction is brick veneer and is popular for houses and small buildings. The internal frame, usually timber or steel is built with a single outer skin of bricks that are tied to the frame for structural stability. Between the internal frame and outer brickwork is a cavity of about 40- 50 mm which acts as a natural barrier to water ingress.

TYPE B: CAVITY MASONRY CONSTRUCTION

Double-skin masonry, typically double brick, is a more traditional style of construction still favoured in hot, dry climates due to its

superior thermal insulation characteristics. It features an inner and outer skin of bricks separated by a cavity, usually 50 mm, with the inner and outer skins tied together for structural stability

TYPE C: SINGLE SKIN VENEER CONSTRUCTION

Clad construction is a simple, cost effective construction technique featuring either a timber or steel frame over which an external cladding is fixed directly. There are many different types of cladding that are popular including masonry fibre sheeting, shiplap, timber, PVC and composites. Cladding systems do not typically have a cavity in the wall, and require a higher degree of diligence and workmanship to achieve an adequate seal.

TYPE D: SOLID MASONRY CONSTRUCTION

Solid masonry walls are sometimes seen in residential constructions, though are common in commercial applications. Blockwork is a form of masonry construction popular in low-rise constructions. It is usually constructed using hollow concrete blocks. These blocks can be left hollow, however to improve structural stability, the hollow core is often reinforced with steel and filled with concrete. Another form of solid masonry wall construction is Tilt Slab which has become prevalent in the last two decades. Concrete wall sections are pre-fabricated in a factory, transported to site and assembled. Generally the individual concrete panels are tied to a steel frame however they may be free-standing.

HOW TO USE THIS GUIDE

This guide is divided into four sections based on the four main construction types:

- Cavity veneer construction
- Cavity masonry construction
- Single skin veneer construction
- Solid masonry construction

The installation diagrams are then collated by frame material type as follows:

Construction type

- Aluminium Window Installation
- Aluminium Sliding Door Installation
- uPVC Window Installation
- uPVC Sliding Door Installation
- Timber Window Installation
- Timber Sliding Door Installation

This guide is designed to be used in conjunction with the AGWA Industry Guide to Fixing to ensure that windows and doors are fixed with an appropriate gauge and spacing for the site specific wind loads.

KEY

- aluminium
- brick
- cladding
- fixing
- flashing
- glass/glazing
- impervious film
- packer
- masonry/concrete
- masonry plug
- mortar
- sarking
- metal (lintel, steel reinforcement)
- sealant/caulk
- stud frame
- timber (frame, reveal, architrave)
- uPVC

CAVITY VENEER CONSTRUCTION

ALUMINIUM WINDOW INSTALLATION

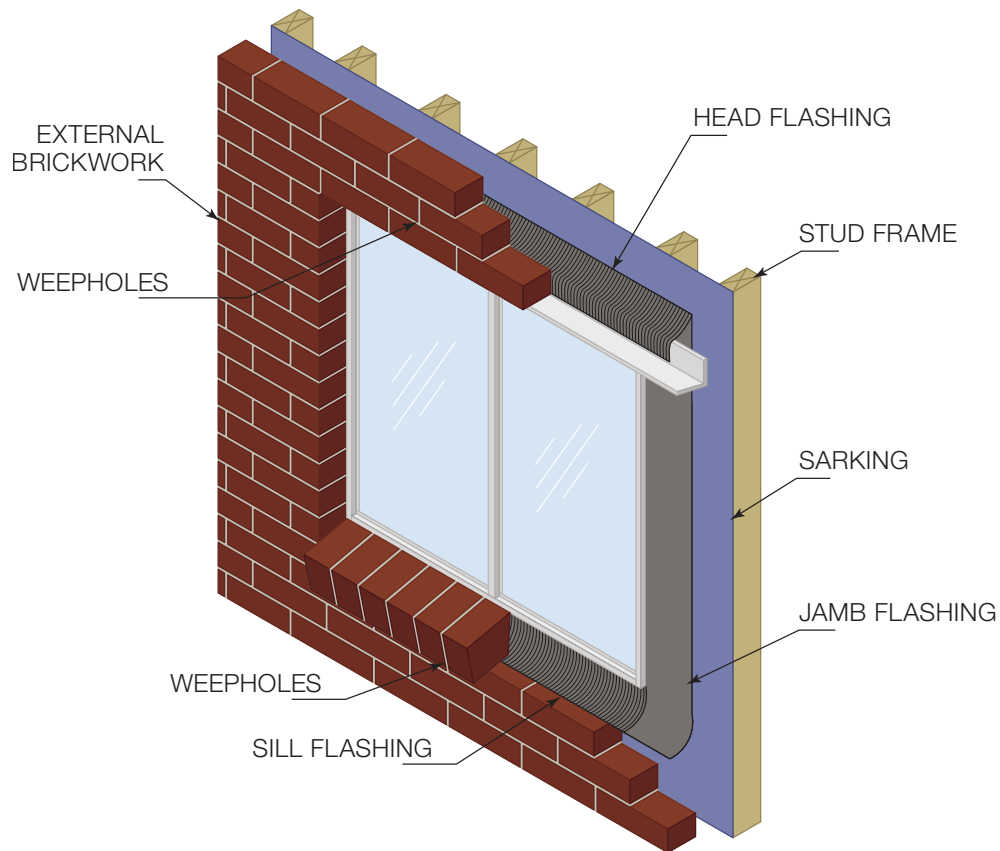

IMPORTANT

Ensure building loads do not bear on window.

Separate the window sill and outside brick skin with an isolating material to prevent possible reaction between brick/mortar and the aluminium framing. Contact can lead to extensive corrosion.

Sill must be level side to side and front to back, and fully supported at all times.

CAVITY VENEER CONSTRUCTION

ALUMINIUM WINDOW INSTALLATION

Head

1. Sarking overlaps head flashing.
2. Head flashing (mandatory) goes into, or one course above, lintel. Head flashing goes over jamb flashing.
3. Maximum spacing for weepholes in brickwork is 1200 mm (from centres).
4. Sealant (exterior).
5. Window head fitted to timber reveal.
6. Fix reveal to lintel with a fixing of a gauge and spacing appropriate for the wind load.

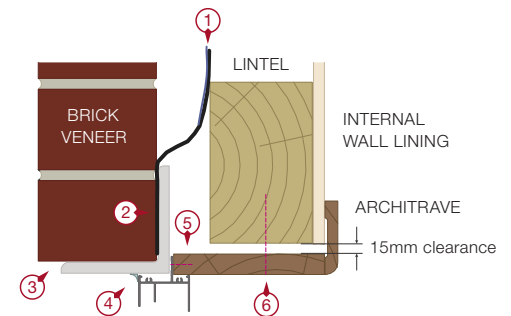

Jamb

1. Packer.
2. Fix reveal to stud frame with a fixing of a gauge and spacing appropriate for the wind load.
3. Jamb flashing attached to the window or wall framing.
4. Sealant (exterior).
5. Jamb flashing overlaps sarking.

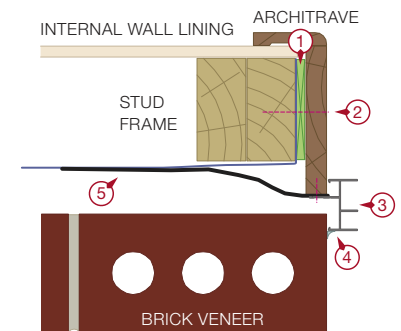

Sill

1. Mandatory sill clearance of 10 mm. Shown with optional sill flap.
2. Sill flashing (mandatory) sandwiched between fixing fin and rereveal.
3. Fix reveal to stud frame with a fixing of a gauge and spacing appropriate for the wind load.
4. Pack sill level where required.
5. Sarking.
6. Preferred flashing position (one brick course down).
7. Alternate flashing position.
8. Weepholes in brickwork must be above flashing. Max spacing is 1200 mm (from centres).

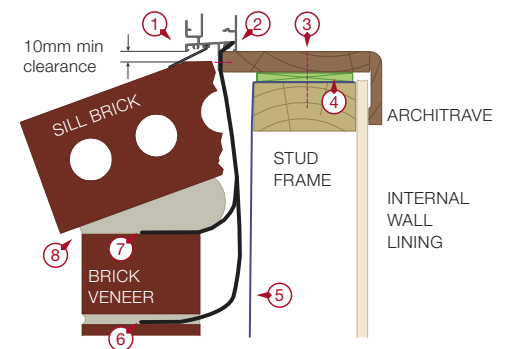

CAVITY VENEER CONSTRUCTION

ALUMINIUM SLIDING DOOR INSTALLATION

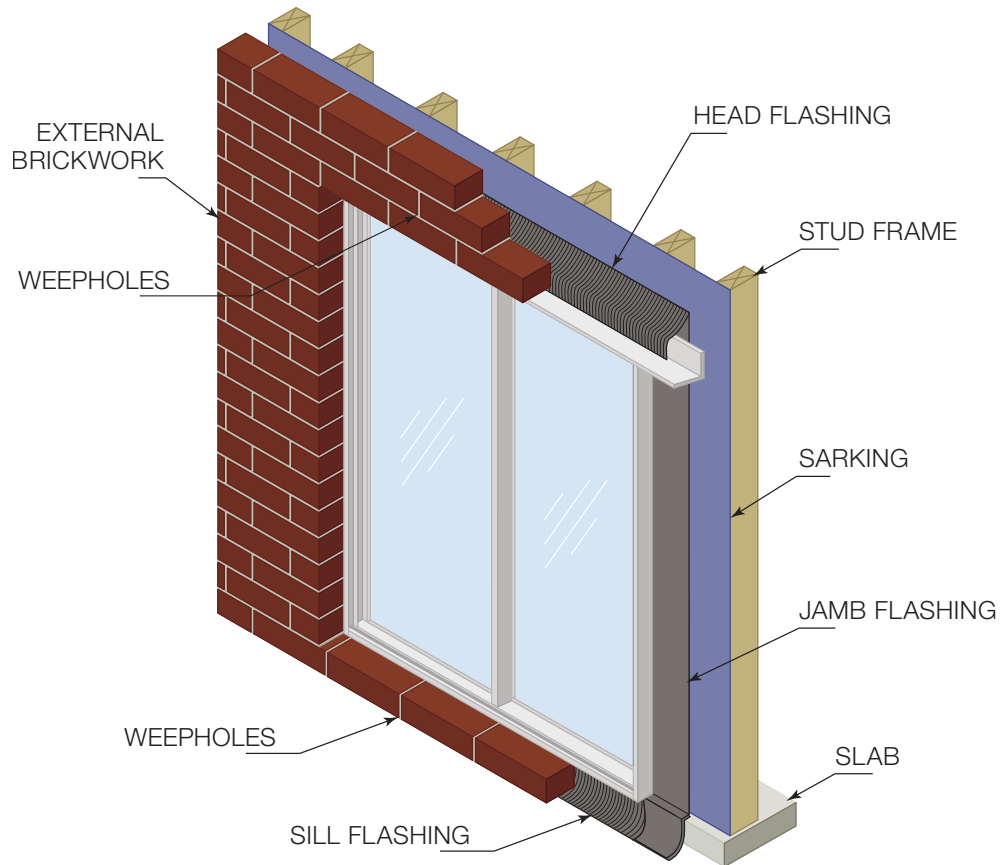

IMPORTANT

Ensure building loads do not bear on door.

Separate the Sill and outside brick skin with an isolating material to prevent possible reaction between brick/mortar and the aluminium framing. Contact can lead to extensive corrosion.

Sill must be level side to side and front to back, and fully supported at all times.

CAVITY VENEER CONSTRUCTION

ALUMINIUM SLIDING DOOR INSTALLATION

Head

1. Sarking overlaps head flashing.
2. Head flashing (mandatory) goes into, or one course above, lintel. Head flashing goes over jamb flashing.
3. Maximum spacing for weepholes in brickwork is 1200 mm (from centres).
4. Sealant (exterior).
5. Door head fitted to timber reveal.
6. Fix reveal to stud lintel with a fixing of a gauge and spacing appropriate for the wind load.

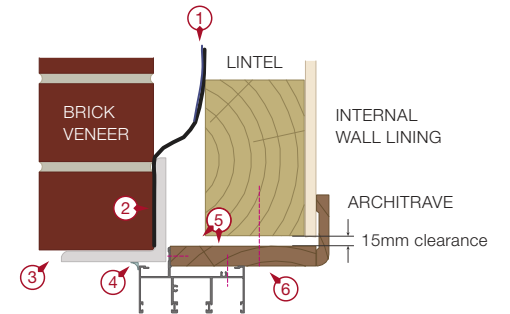

Jamb

1. Packer.
2. Fix reveal to stud frame with a fixing of a gauge and spacing appropriate for the wind load.
3. Jamb flashing attached to the door or wall framing
4. Sealant (exterior).
5. Jamb flashing overlaps sarking.

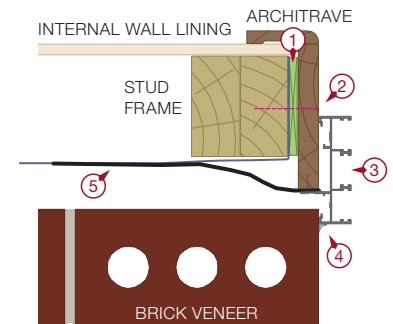

Sill

1. Angle trim sealed to structure and door sill (with masonry plug where required).
2. Pack sill to level where required.
3. Sill flashing tray (mandatory) turned up and sealed at each end.
4. Weepholes must be above sill flashing. Maximum spacing for weepholes in brickwork is 1200 mm (from centres).

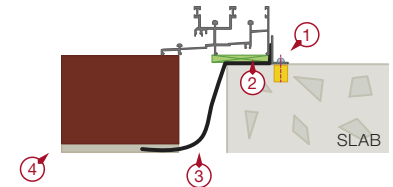

CAVITY VENEER CONSTRUCTION

UPVC WINDOW INSTALLATION

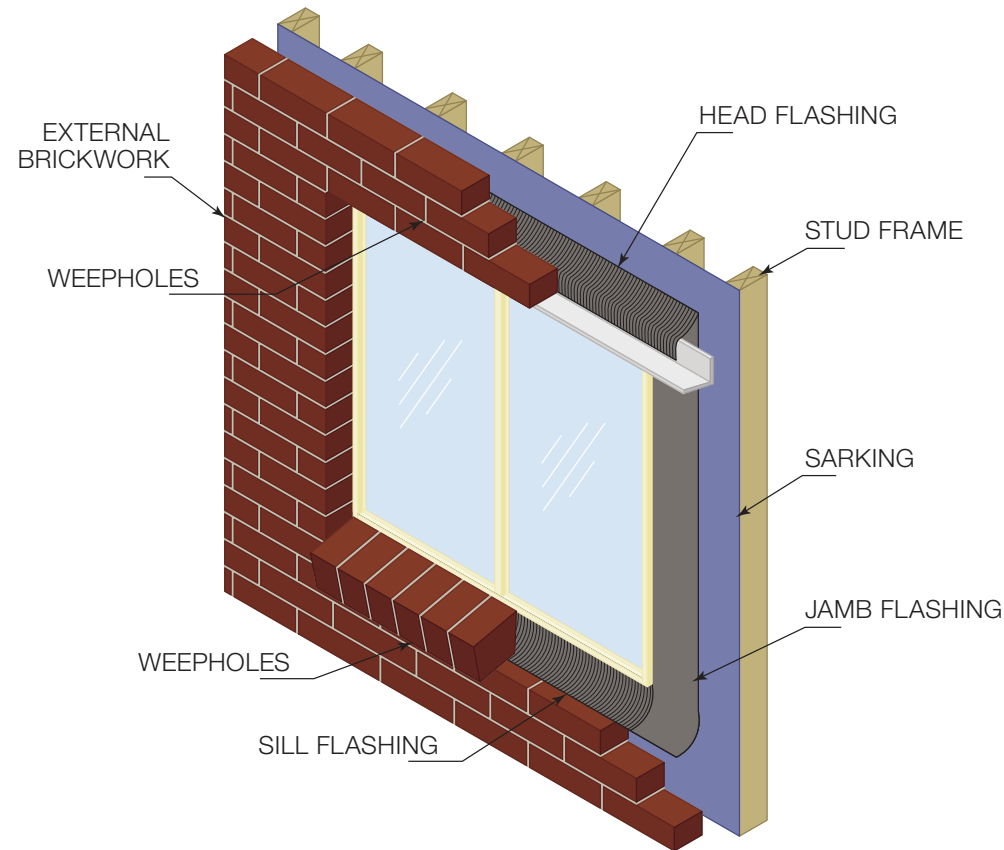

IMPORTANT

Ensure building loads do not bear on window.

Sill must be level side to side and front to back, and fully supported at all times.

CAVITY VENEER CONSTRUCTION

UPVC WINDOW INSTALLATION

Head

1. Sarking overlaps head flashing.
2. Head flashing (mandatory) goes into, or one course above, lintel. Head flashing goes over jamb flashing.
3. Maximum spacing for weepholes in brickwork is 1200 mm (from centres).
4. Sealant (exterior).
5. Window fitted to timber reveal.
6. Fix reveal to lintel with a fixing of a gauge and spacing appropriate for the wind load.

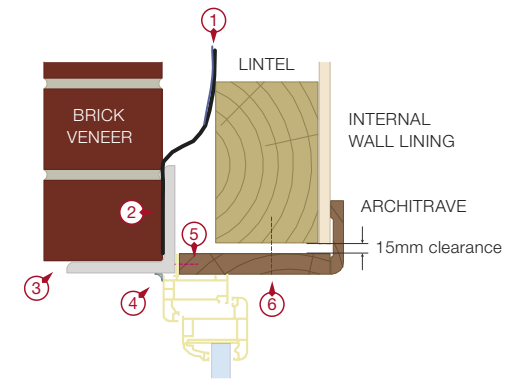

Jamb

1. Packer.
2. Fix reveal to lintel with a fixing of a gauge and spacing appropriate for the wind load.
3. Sealant (exterior).
4. Jamb flashing attached to the window or wall framing.
5. Jamb flashing overlaps sarking.

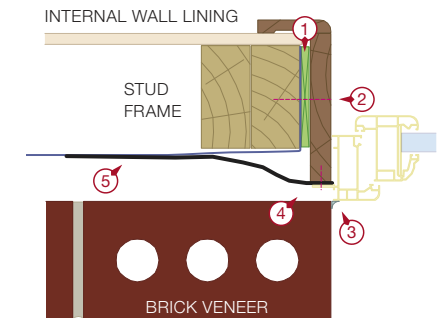

Sill

1. Mandatory sill clearance is 10 mm. Shown here with optional sill flap.
2. Sill flashing (mandatory) sandwiched between window fixing fin and reveal.
3. Fix reveal to lintel with a fixing of a gauge and spacing appropriate for the wind load.
4. Pack sill to level where required.
5. Sarking.
6. Preferred flashing position.
7. Alternate flashing position.
8. Maximum spacing for weepholes in brickwork is 1200 mm (from centres). Keep weepholes above flashing.

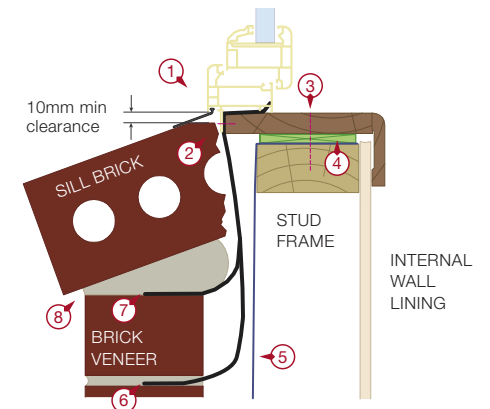

CAVITY VENEER CONSTRUCTION

UPVC SLIDING DOOR INSTALLATION

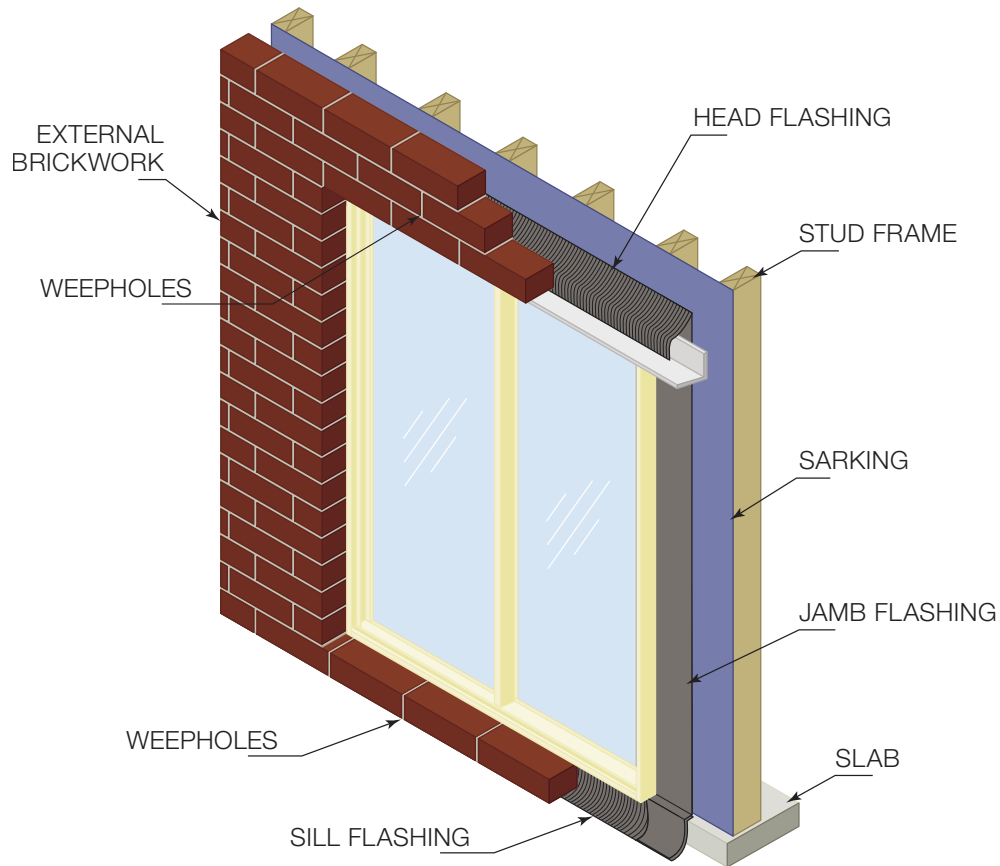

IMPORTANT

Ensure building loads do not bear on door.

Sill must be level side to side and front to back, and fully supported at all times.

CAVITY VENEER CONSTRUCTION

UPVC SLIDING DOOR INSTALLATION

Head

1. Sarking overlaps head flashing.
2. Head flashing (mandatory) goes into, or one course above, lintel. Head flashing goes over jamb flashing.
3. Maximum spacing for weepholes in brickwork is 1200 mm (from centres).
4. Sealant (exterior).
5. Door head fitted to timber reveal.
6. Fix reveal to lintel with a fixing of a gauge and spacing appropriate for the wind load.

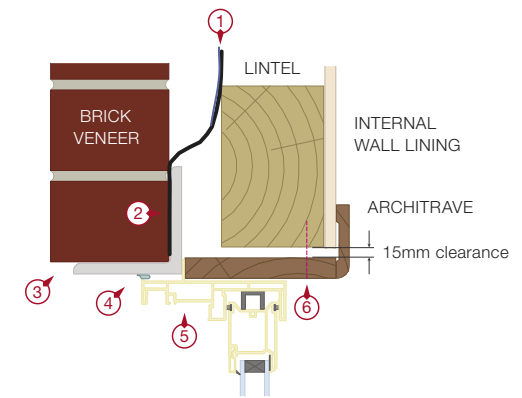

Jamb

1. Packer.
2. Fix reveal to studwork with a fixing of a gauge and spacing appropriate for the wind load.
3. Jamb flashing attached to the door or wall framing.
4. Sealant (exterior).
5. Jamb flashing overlaps sarking.

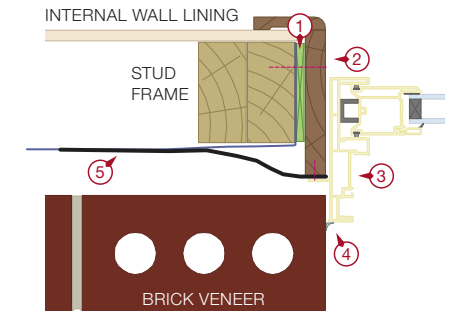

Sill

1. Angle trim sealed to structure and door sill (with masonry plug).
2. Pack sill to level where required.
3. Sill flashing tray (mandatory) turned up and sealed at each end.
4. Maximum spacing for weepholes in brickwork is 1200 mm (from centres). Keep weepholes above flashing.

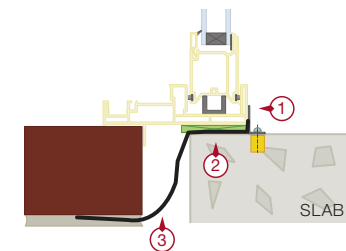

CAVITY VENEER CONSTRUCTION

TIMBER WINDOW INSTALLATION

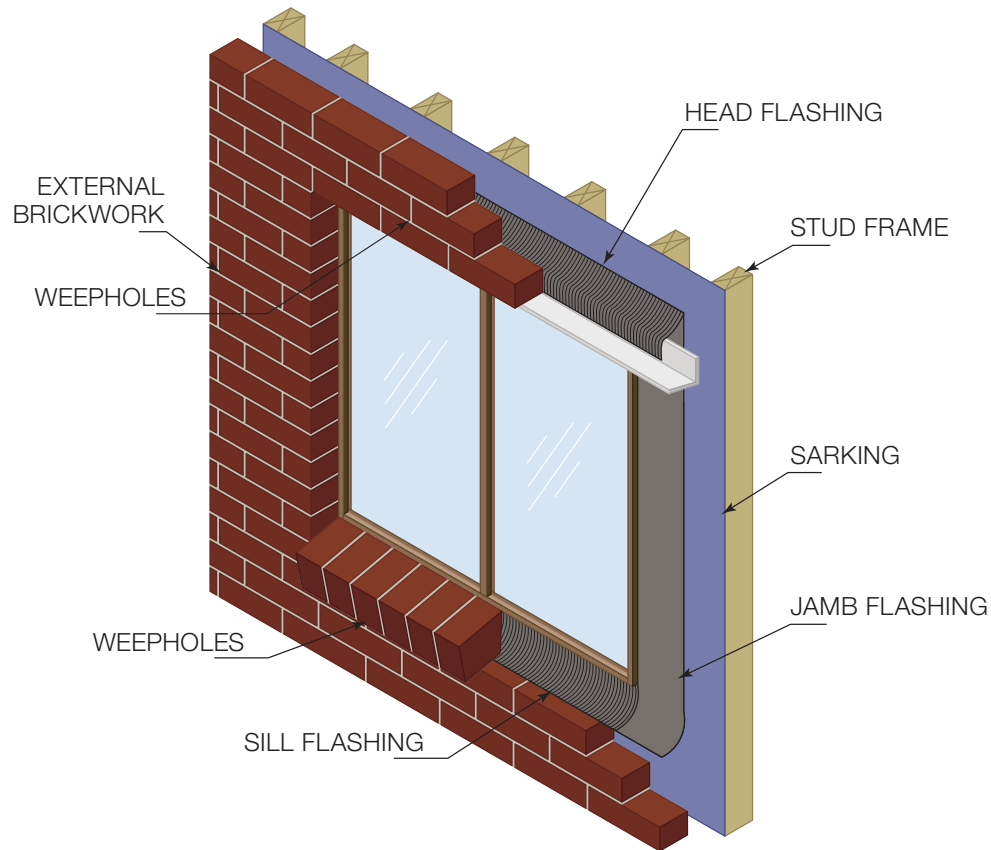

IMPORTANT

Ensure building loads do not bear on window.

Sill must be level side to side and front to back, and fully supported at all times.

CAVITY VENEER CONSTRUCTION

TIMBER WINDOW INSTALLATION

Head

1. Sarking overlaps head flashing.
2. Head flashing goes into, or one course above, lintel. Head flashing goes over jamb flashing.
3. Maximum spacing for weepholes in brickwork is 1200 mm (from centres).
4. Sealant (exterior).
5. Fix reveal to lintel with a fixing of a gauge and spacing appropriate for the wind load.

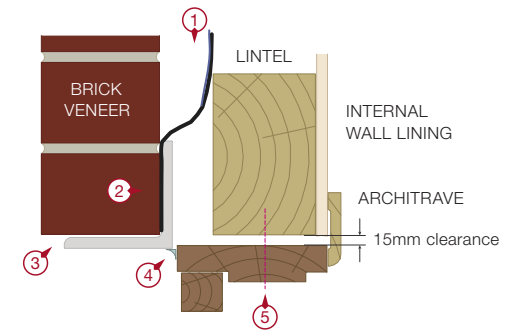

Jamb

1. Packer.
2. Fix reveal to studwork with a fixing of a gauge and spacing appropriate for the wind load.
3. Storm Mould or Sealant (exterior).
4. Jamb flashing attached to the window or wall framing.

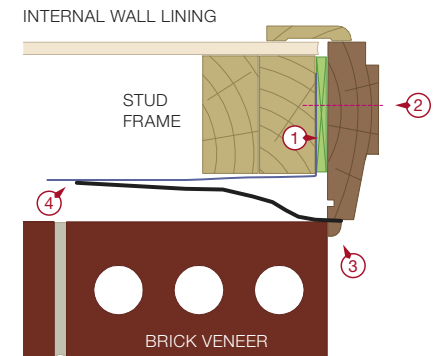

Sill

1. Sill flashing (mandatory) sandwiched between window frame and architrave.
2. Fix reveal to studwork with a fixing of a gauge and spacing appropriate for the wind load.
3. Pack sill to level where required.
4. Sarking.
5. Preferred flashing position.
6. Alternate flashing position.
7. Maximum spacing for weepholes in brickwork is 1200 mm (from centres). Keep weepholes above flashing.

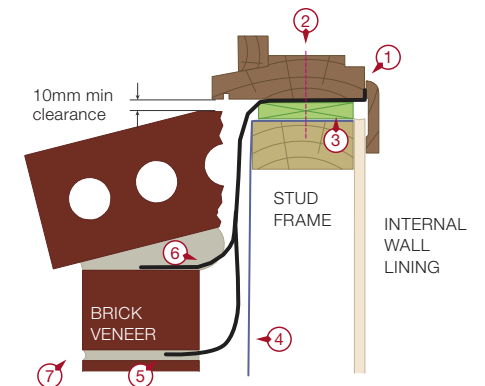

CAVITY VENEER CONSTRUCTION

TIMBER SLIDING DOOR INSTALLATION

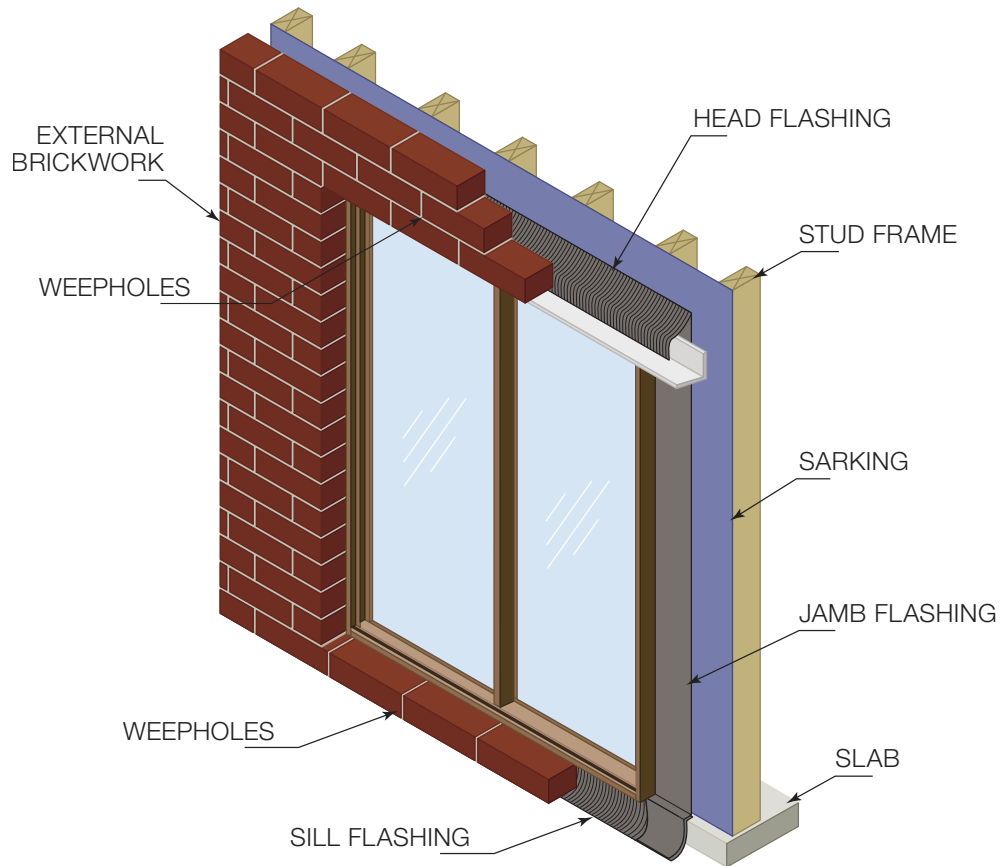

IMPORTANT

Ensure building loads do not bear on door.

Sill must be level side to side and front to back, and fully supported at all times.

CAVITY VENEER CONSTRUCTION

TIMBER SLIDING DOOR INSTALLATION

Head

1. Sarking overlaps head flashing.
2. Head flashing goes into, or one course above, lintel. Head flashing goes over jamb flashing.
3. Maximum spacing for weepholes in brickwork is 1200 mm (from centres).
4. Fix reveal to lintel with a fixing of a gauge and spacing appropriate for the wind load.
5. Sealant (exterior).

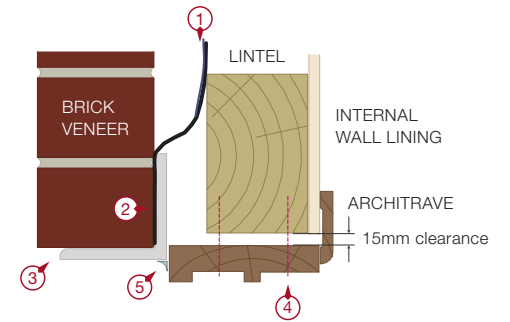

Jamb

1. Jamb flashing attached to the window or wall framing.
2. Packer.
3. Fix reveal to studwork with a fixing of a gauge and spacing appropriate for the wind load.
4. Storm Mould or Sealant (exterior).

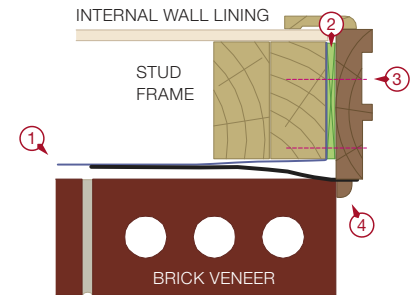

Sill

1. Pack sill to level where required.
2. Sill flashing tray (mandatory) turned up and sealed at each end.
3. Angle trim sealed to structure and door sill (with masonry plug where required).

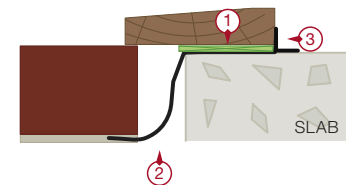

CAVITY MASONRY CONSTRUCTION

ALUMINIUM WINDOW INSTALLATION

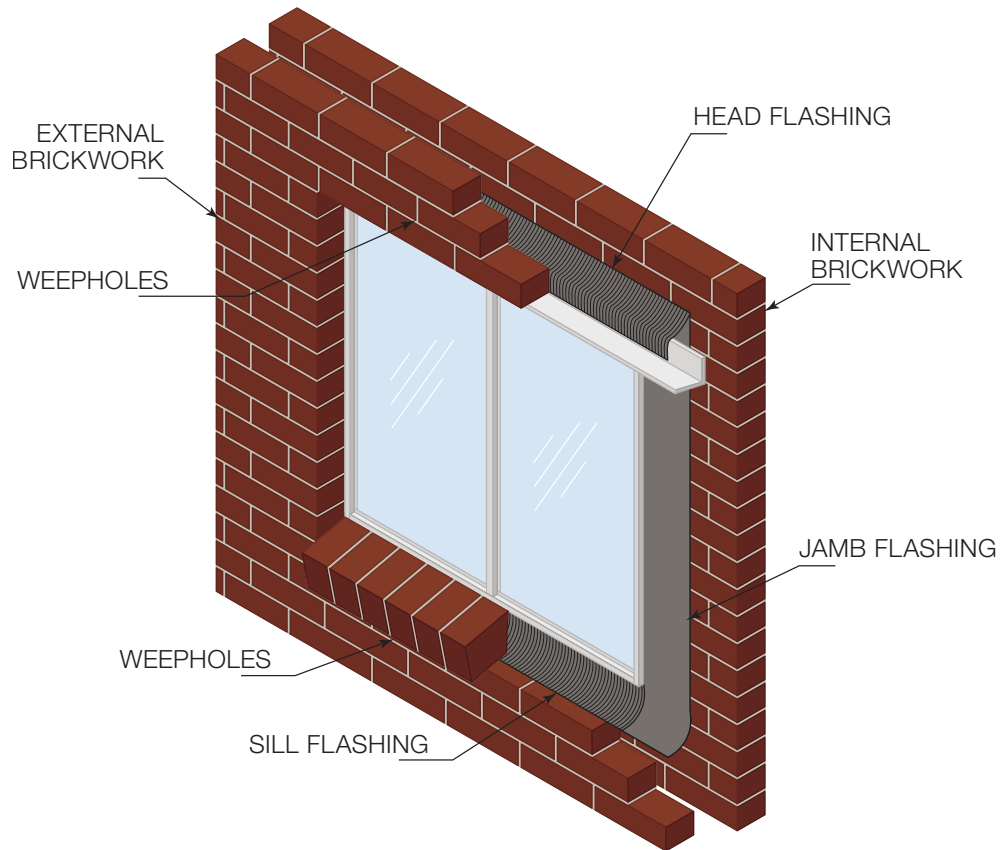

IMPORTANT

Ensure building loads do not bear on window.

Separate the Sill and outside brick skin with an isolating material to prevent possible reaction between brick/mortar and the aluminium framing. Contact can lead to extensive corrosion.

Sill must be level side to side and front to back, and fully supported at all times.

CAVITY MASONRY CONSTRUCTION

ALUMINIUM WINDOW INSTALLATION

Head

1. Head flashing (mandatory) built into inner skin a minimum of 30 mm.
2. Head flashing goes into, or one course above, lintel. Head flashing goes over jamb flashing.
3. Maximum spacing for weepholes in brickwork is 1200 mm (from centres).
4. Sealant (exterior).
5. Window screwed to lintel or fixed with galvanised strap.
6. Sealant (interior).

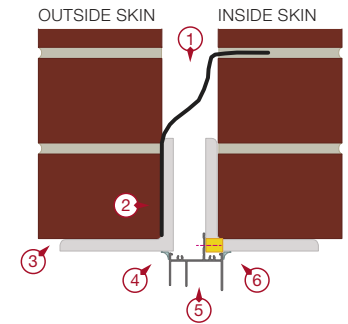

Jamb

1. Jamb flashing in front of window fixing fin.
2. Brick lug clipped to fixing fin at spacing appropriate for the wind load. Ensure lugs 'tie in' with the mortar.
3. Sealant (interior).
4. Sealant (exterior).

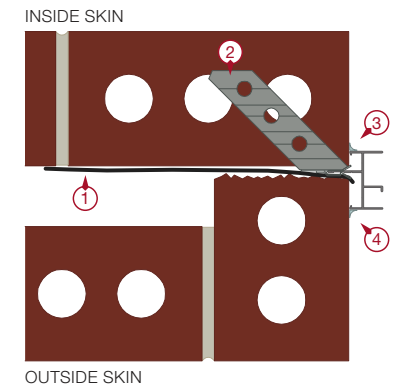

Sill

1. Sill flap (optional).
2. Sealant (interior).
3. Sill flashing (mandatory) sandwiched behind window fixing fin.
4. Preferred flashing position (one brick course down).
5. Alternate flashing position.
6. Weepholes must be above flashing. Maximum spacing for weepholes in brickwork is 1200 mm (from centres).

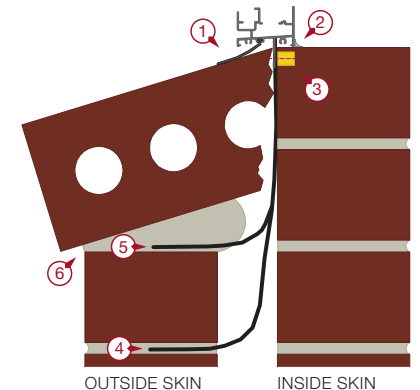

CAVITY MASONRY CONSTRUCTION

ALUMINIUM SLIDING DOOR INSTALLATION

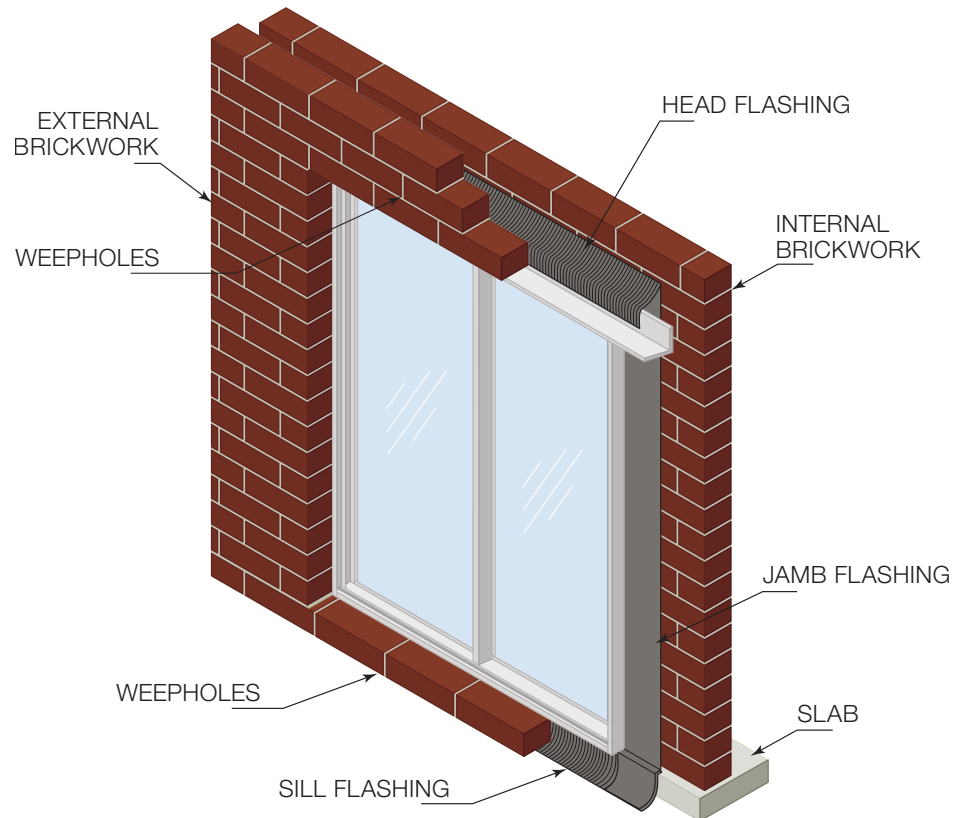

IMPORTANT

Ensure building loads do not bear on door.

Separate the Sill and outside brick skin with an isolating material to prevent possible reaction between brick/mortar and the aluminium framing. Contact can lead to extensive corrosion.

Sill must be level side to side and front to back, and fully supported at all times.

CAVITY MASONRY CONSTRUCTION

ALUMINIUM SLIDING DOOR INSTALLATION

Head

1. Head flashing (mandatory) built into inner skin a minimum of 30 mm.
2. Head flashing goes into, or one course above, external lintel. Head flashing goes over jamb flashing.
3. Maximum spacing for weepholes in brickwork is 1200 mm (from centres).
4. Sealant (exterior).
5. Fix door frame to internal lintel with a fixing of a gauge and spacing appropriate for the wind load.
6. Sealant (interior).

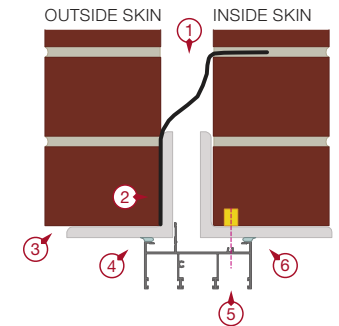

Jamb

1. Jamb flashing in front of door fixing fin.
2. Brick lug clipped to fixing fin at spacing appropriate for the wind load. Ensure lugs 'tie in' with the mortar.
3. Sealant (interior).
4. Sealant (exterior).
5. Brick lug clipped to fixing fin.

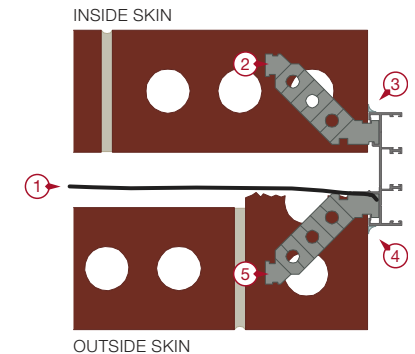

Sill

1. Angle trim sealed to structure and door sill (with masonry plug where required).
2. Pack sill to level where required.
3. Sill flashing tray (mandatory) turned up and sealed at each end.
4. Weepholes must be above flashing. Maximum spacing for weepholes in brickwork is 1200 mm (from centres).

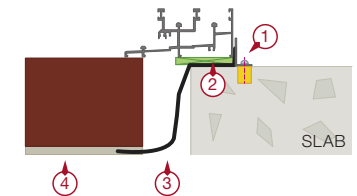

CAVITY MASONRY CONSTRUCTION

UPVC WINDOW INSTALLATION

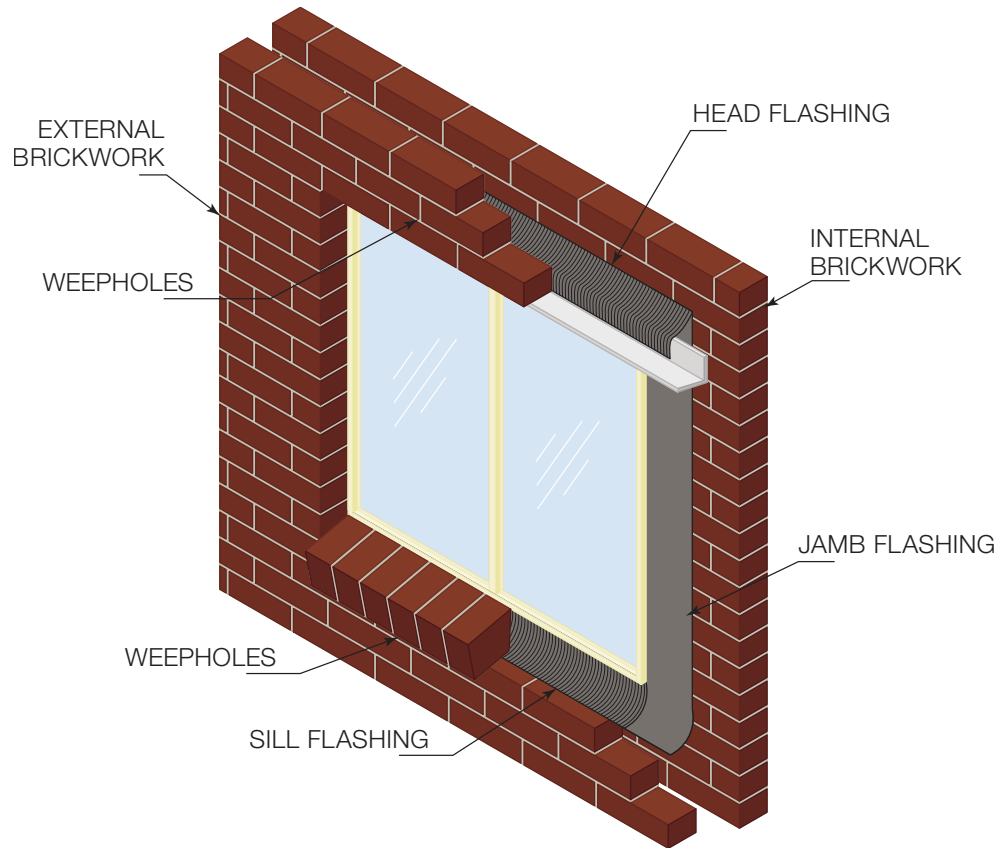

IMPORTANT

Ensure building loads do not bear on window.

Sill must be level side to side and front to back, and fully supported at all times.

CAVITY MASONRY CONSTRUCTION

UPVC WINDOW INSTALLATION

Head

1. Head flashing (mandatory) built into inner skin a minimum of 30 mm.
2. Head flashing goes into, or one course above, lintel. Head flashing goes over jamb flashing.
3. Window screwed to lintel or fixed with galvanised strap.
4. Maximum spacing for weepholes in brickwork is 1200 mm (from centres).
5. Sealant (exterior).
6. Sealant (interior).

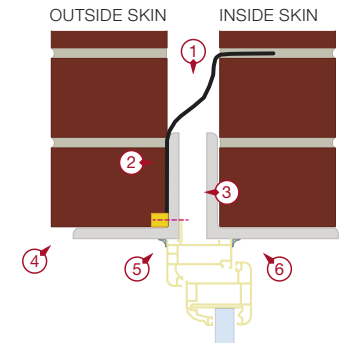

Jamb

1. Jamb flashing in front of window fixing fin.
2. Brick lug clipped to fixing fin at spacing appropriate for the wind load. Ensure lugs 'tie in' with the mortar.
3. Sealant (exterior).
4. Sealant (interior).

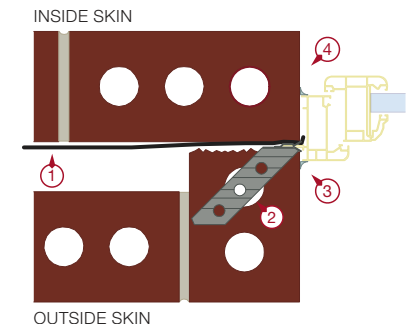

Sill

1. Sill flap (optional).
2. Sill flashing (mandatory) behind window fixing fin.
3. Sealant (interior).
4. Preferred flashing position (one course down).
5. Alternate flashing position.
6. Maximum spacing for weepholes in brickwork is 1200 mm (from centres). Keep weepholes above flashing.

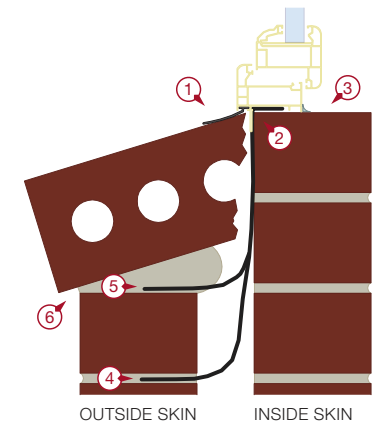

CAVITY MASONRY CONSTRUCTION

UPVC SLIDING DOOR INSTALLATION

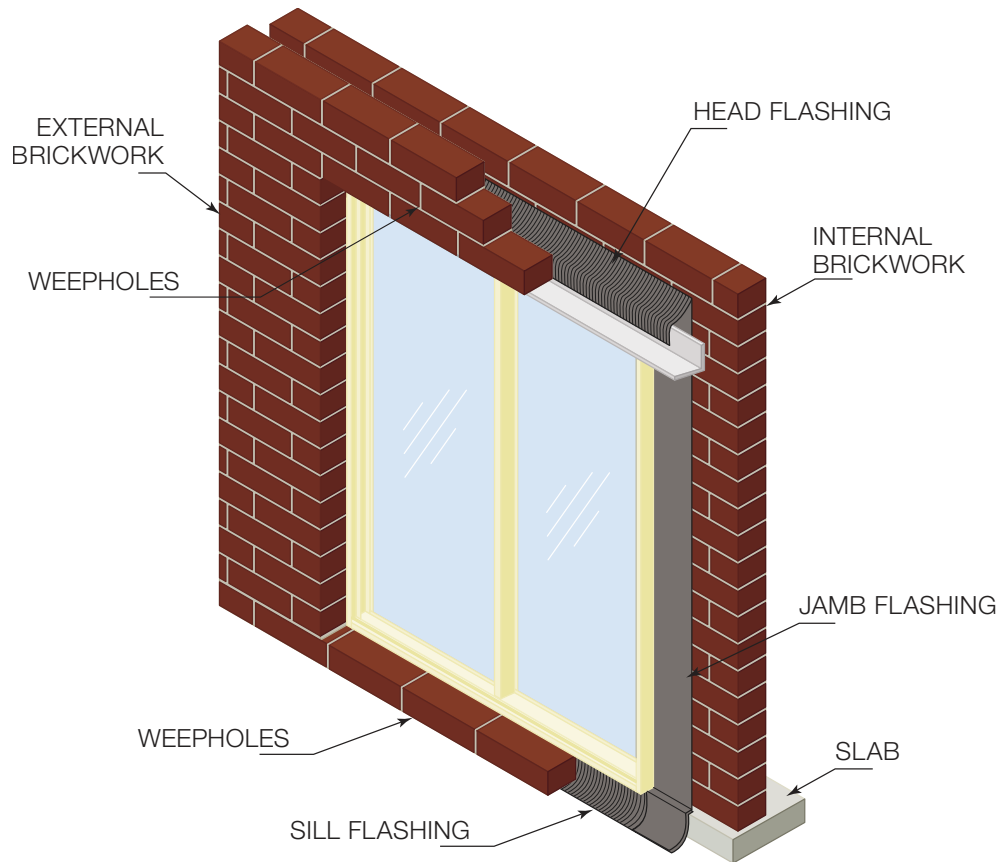

IMPORTANT

Ensure building loads do not bear on door.

Sill must be level side to side and front to back, and fully supported at all times.

CAVITY MASONRY CONSTRUCTION

UPVC SLIDING DOOR INSTALLATION

Head

1. Head flashing (mandatory) built into inner skin a minimum of 30 mm.
2. Head flashing goes into, or one course above, lintel. Head flashing goes over jamb flashing.
3. Window screwed to lintel or fixed with galvanised strap.
4. Maximum spacing for weepholes in brickwork is 1200 mm (from centres).
5. Sealant (exterior).
6. Sealant (interior).

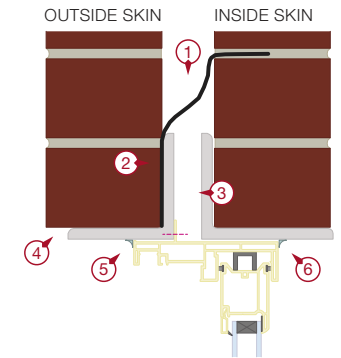

Jamb

1. Jamb flashing.
2. Brick lug clipped to fixing fin at spacing appropriate for the wind load. Ensure lugs 'tie in' with the mortar.
3. Sealant (exterior).
4. Sealant (interior).

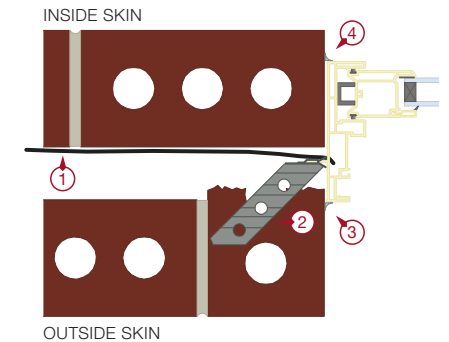

Sill

1. Sill supported.
2. Angle trim sealed to structure and door sill (with masonry plug where required).
3. Sill flashing tray (mandatory) turned up and sealed at each end.
4. Maximum spacing for weepholes in brickwork is 1200 mm (from centres). Keep weepholes above flashing.

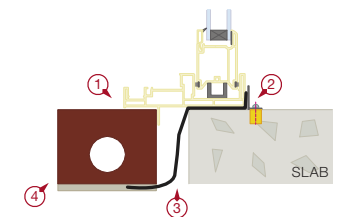

CAVITY MASONRY CONSTRUCTION

TIMBER WINDOW INSTALLATION

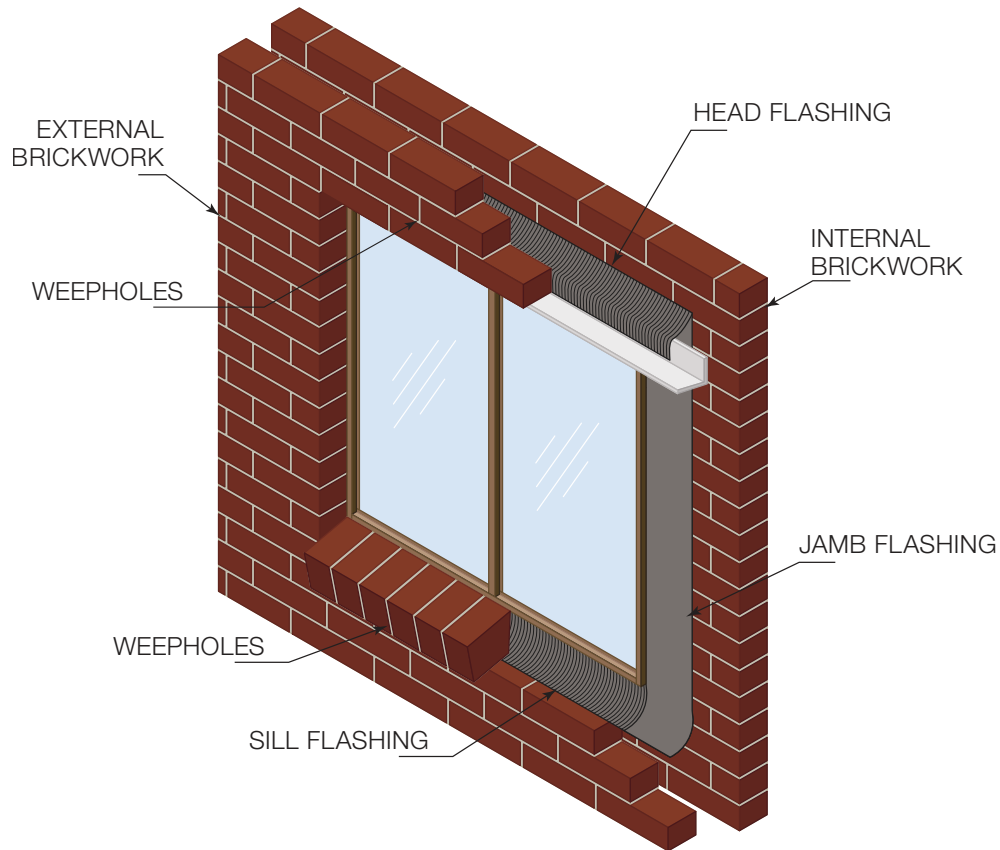

IMPORTANT

Ensure building loads do not bear on window.

Sill must be level side to side and front to back, and fully supported at all times.

CAVITY MASONRY CONSTRUCTION

TIMBER WINDOW INSTALLATION

Head

1. Head flashing (mandatory) built into inner skin a minimum of 30 mm.
2. Head flashing goes into, or one course above, external lintel. Head flashing goes over jamb flashing.
3. Maximum spacing for weepholes in brickwork is 1200 mm (from centres).
4. Fix reveal to lintel with a fixing of a gauge and spacing appropriate for the wind load.
5. Sealant (exterior).
6. Sealant (interior).

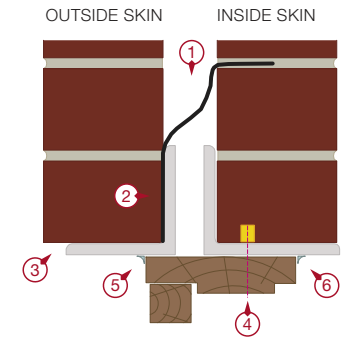

Jamb

1. Jamb flashing attached to outer course storm mould with flashing sandwiched between it and window frame.
2. Masonry plug.
3. Fix reveal to brickwork with a fixing of a gauge and spacing appropriate for the wind load.
4. Sealant (interior).
5. Storm Mould or Sealant (exterior).

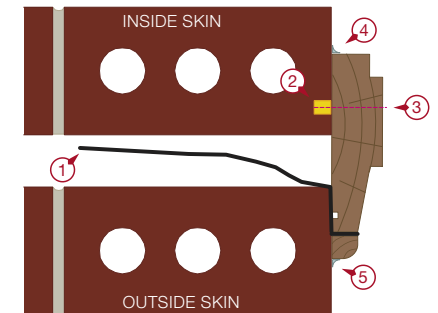

Sill

1. Mandatory 10 mm sill clearance.
2. Fix frame with a fixing of a gauge and spacing appropriate for the wind load.
3. Pack sill to level where required.
4. Sill Flashing Tray behind sill trimmer.
5. Preferred flashing position (one course down).
6. Alternate flashing position.
7. Weepholes must be above flashing. Maximum spacing for weepholes in brickwork is 1200 mm (from centres).

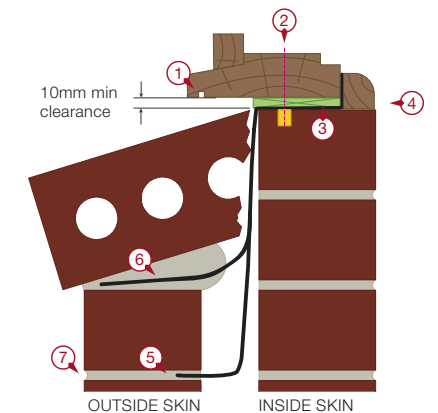

CAVITY MASONRY CONSTRUCTION

TIMBER SLIDING DOOR INSTALLATION

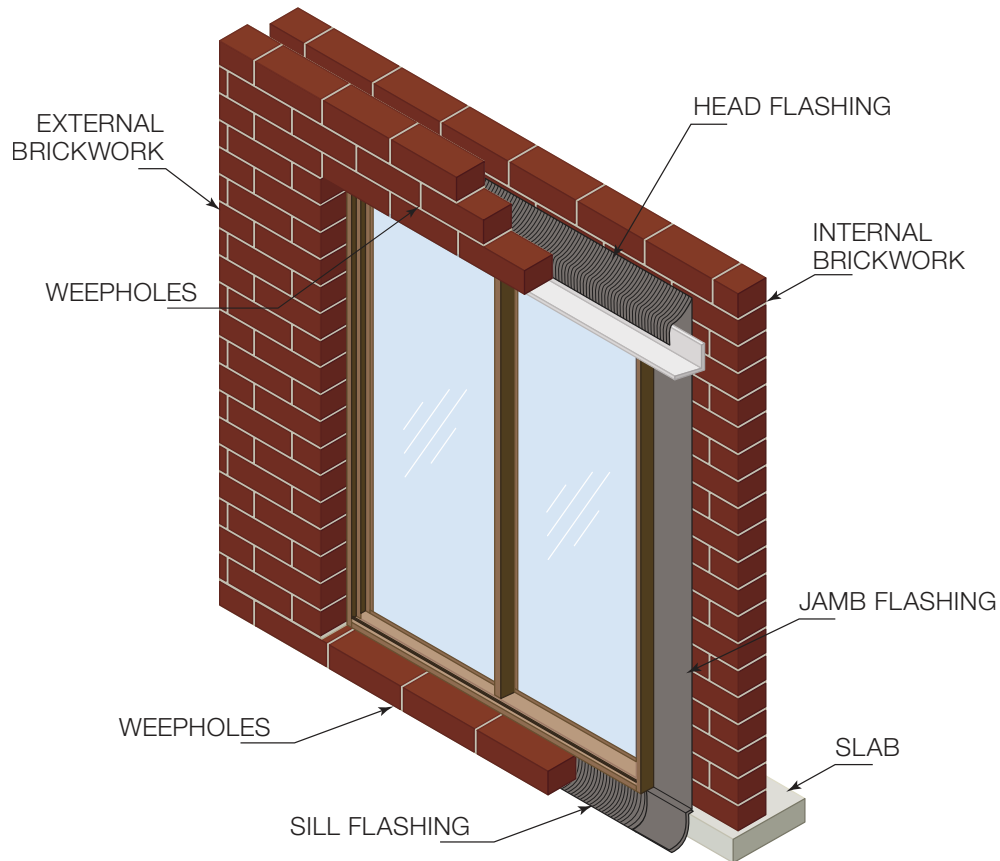

IMPORTANT

Ensure building loads do not bear on door.

Sill must be level side to side and front to back, and fully supported at all times.

CAVITY MASONRY CONSTRUCTION

TIMBER SLIDING DOOR INSTALLATION

Head

1. Head flashing (mandatory) built into inner skin a minimum of 30 mm.
2. Head flashing goes into, or one course above, external lintel. Head flashing goes over jamb flashing.
3. Maximum spacing for weepholes in brickwork is 1200 mm (from centres).
4. Fix reveal to lintel with a fixing of a gauge and spacing appropriate for the wind load with masonry plugs where required.
5. Sealant (interior).
6. Sealant (exterior).

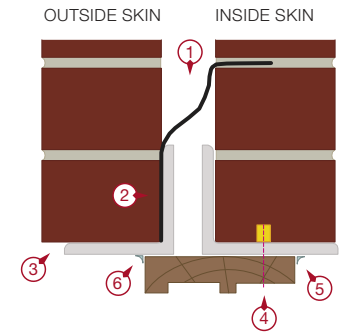

Jamb

1. Jamb flashing attached to outer course storm mould with flashing sandwiched between it and window frame.
2. Fix window frame with a fixing of a gauge and spacing appropriate for the wind load.
3. Masonry plug.
4. Sealant (interior).
5. Storm Mould or Sealant (exterior)

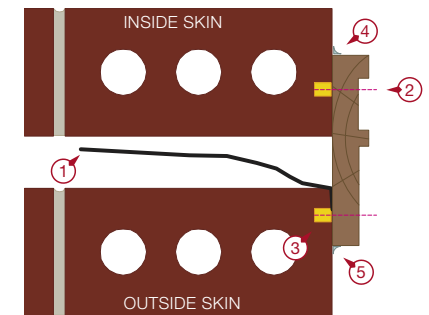

Sill

1. Pack sill to level where required.
2. Sill flashing tray (mandatory) turned up and sealed at each end.
3. Angle trim sealed to structure and door sill (with masonry plug where required).

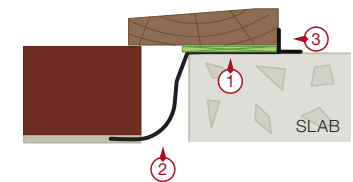

SINGLE SKIN VENEER CONSTRUCTION

ALUMINIUM WINDOW INSTALLATION

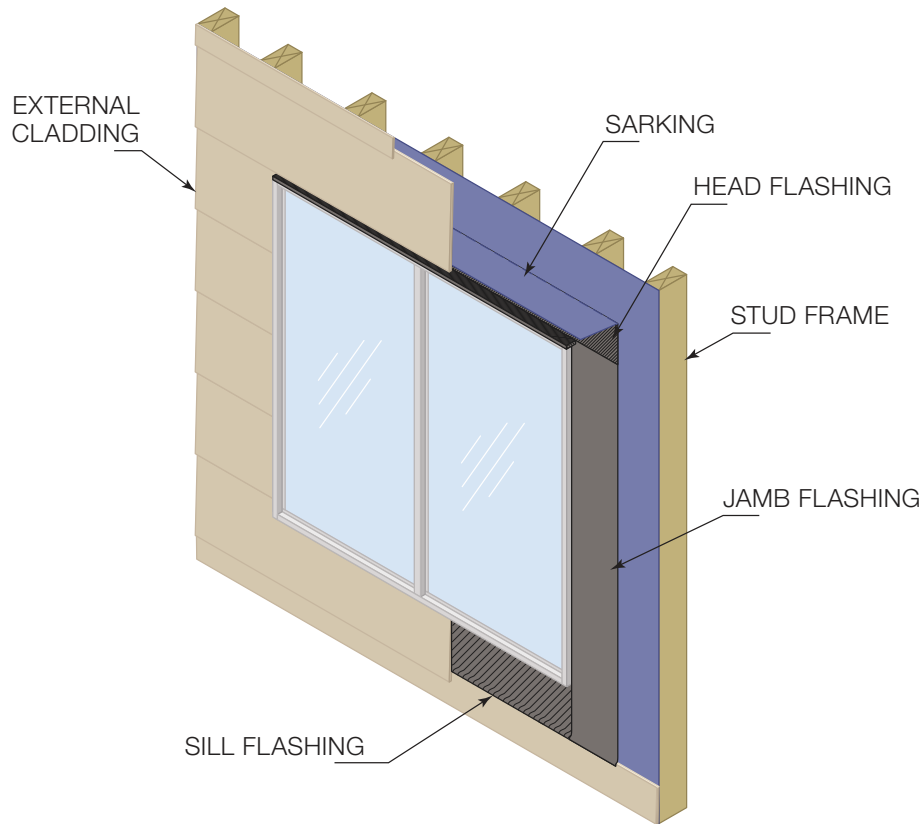

IMPORTANT

Ensure building loads do not bear on window.

Sill must be level side to side and front to back, and fully supported at all times.

SINGLE SKIN VENEER CONSTRUCTION

ALUMINIUM WINDOW INSTALLATION

Head

1. Sarking overlaps head flashing.
2. Pressed metal head flashing. Head flashing goes over jamb flashing and head and extends past window reveal by 150mm either side minimum.
3. Window fitted to timber reveal.
4. Fix reveal to lintel with a fixing of a gauge and spacing appropriate for the wind load.

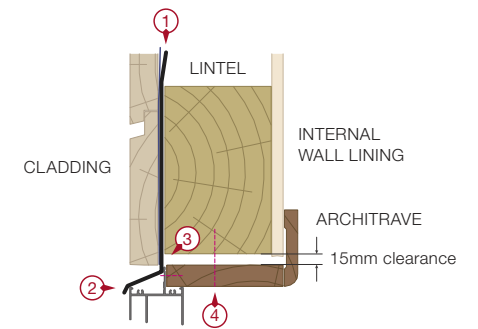

Jamb

1. Jamb flashing overlaps sarking.
2. Packer over sarking.
3. Fix reveal to stud frame with a fixing of a gauge and spacing appropriate for the wind load.
4. Jamb flashing attached to the window and wall framing.
5. Sealant (external).

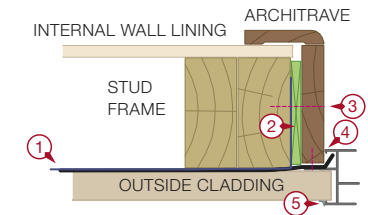

Sill

1. Sill flap (optional).
2. Sill flashing sandwiched between window fixing fin and reveal (mandatory).
3. Fix reveal to lintel with a fixing of a gauge and spacing appropriate for the wind load.
4. Pack sill to level where required.
5. Sill flashing drains to outside.
6. Sarking.

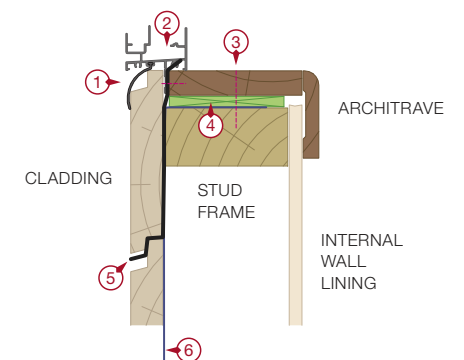

SINGLE SKIN VENEER CONSTRUCTION

ALUMINIUM SLIDING DOOR INSTALLATION

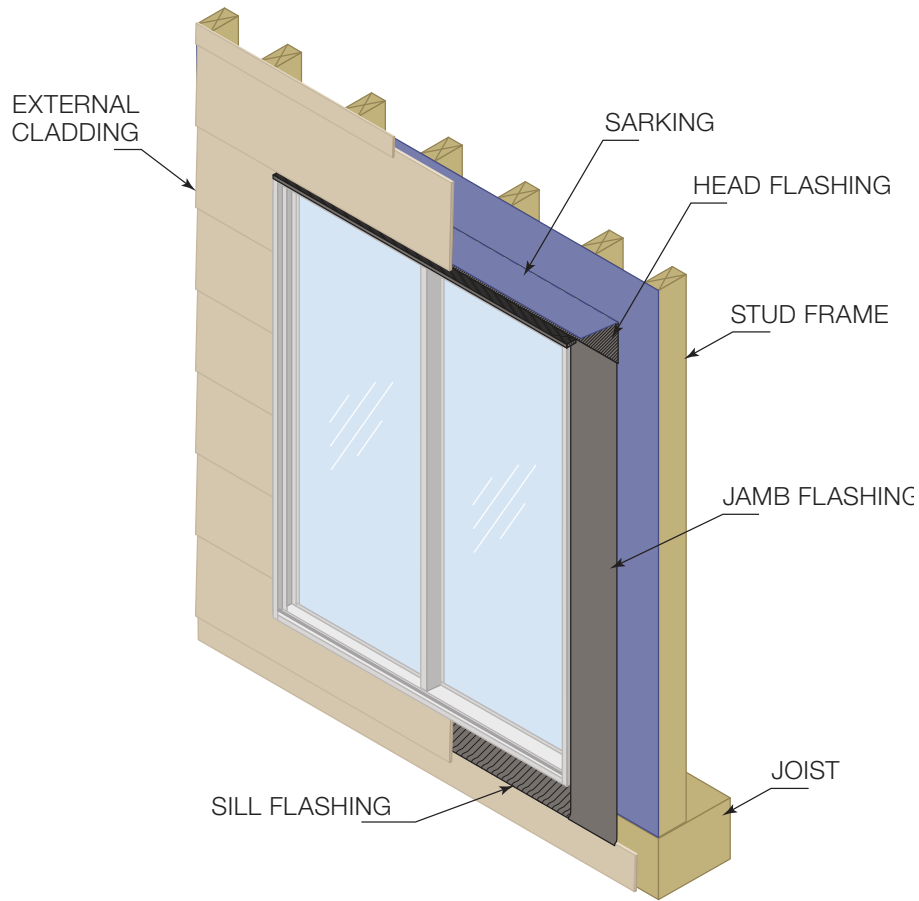

IMPORTANT

Ensure building loads do not bear on door.

Sill must be level side to side and front to back, and fully supported at all times.

SINGLE SKIN VENEER CONSTRUCTION

ALUMINIUM SLIDING DOOR INSTALLATION

Head

1. Sarking overlaps head flashing.
2. Pressed metal head flashing. Head flashing goes over jamb flashing and head and extends past window reveal by 150mm either side minimum.
3. Door head fitted to timber reveal.
4. Fix reveal to lintel with a fixing of a gauge and spacing appropriate for the wind load.

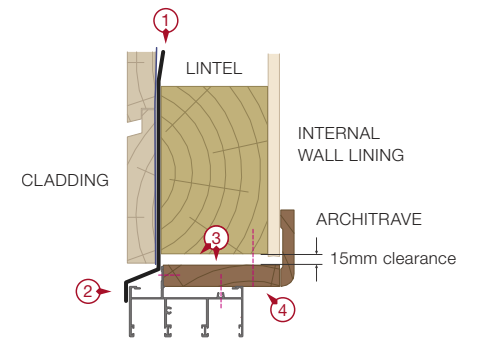

Jamb

1. Jamb flashing overlaps sarking.
2. Packer over sarking.
3. Fix reveal to stud frame with a fixing of a gauge and spacing appropriate for the wind load.
4. Jamb flashing (mandatory) attached to the door and wall framing.
5. Sealant (external).

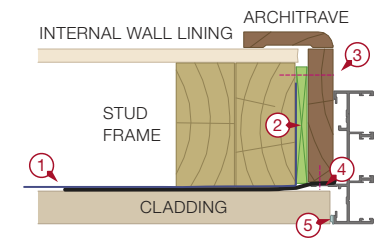

Sill

1. Angle trim sealed to structure and door sill (shown under flooring).
2. Pack sill to level where required.
3. Sill flashing tray (mandatory) turned up and sealed at each end.

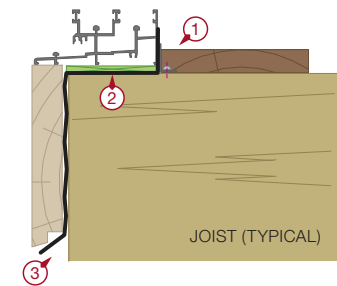

SINGLE SKIN VENEER CONSTRUCTION

UPVC WINDOW INSTALLATION

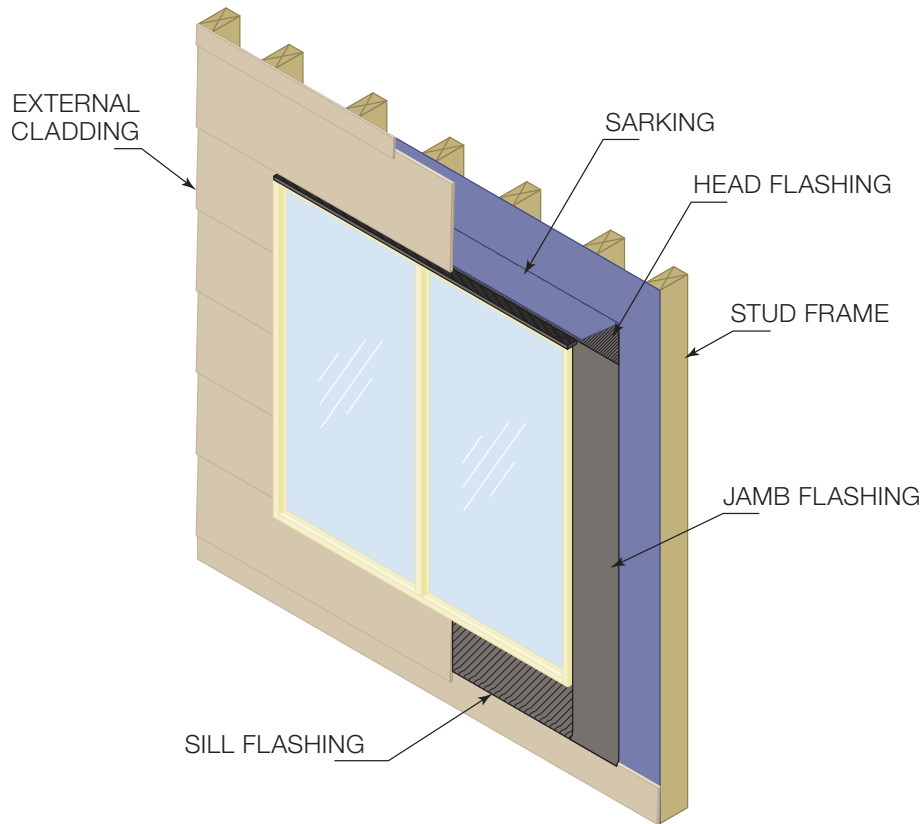

IMPORTANT

Ensure building loads do not bear on window.

Sill must be level side to side and front to back, and fully supported at all times.

SINGLE SKIN VENEER CONSTRUCTION

UPVC WINDOW INSTALLATION

Head

1. Sarking overlaps head flashing.
2. Pressed metal head flashing. Head flashing goes over jamb flashing and head and extends past window reveal by 150mm either side minimum.
3. Window head fitted to timber reveal.
4. Fix reveal to lintel with a fixing of a gauge and spacing appropriate for the wind load.

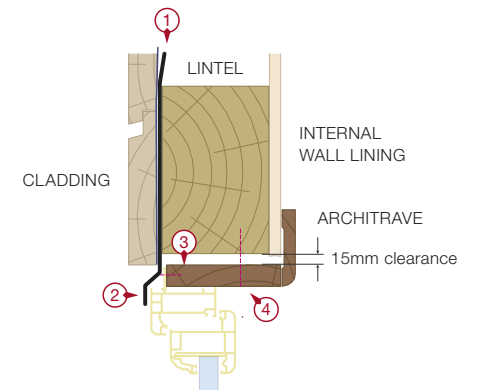

Jamb

1. Jamb flashing overlaps sarking.
2. Packer over sarking.
3. Fix reveal to stud frame with a fixing of a gauge and spacing appropriate for the wind load.
4. Jamb flashing (mandatory) attached to the window and wall framing.
5. Sealant (external).

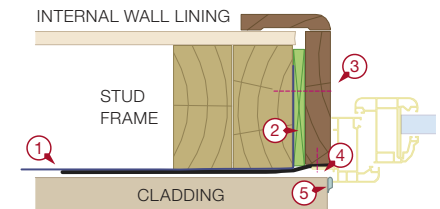

Sill

1. Sill flap (optional).
2. Sill flashing sandwiched between window fixing fin and reveal.
3. Fix reveal to lintel with a fixing of a gauge and spacing appropriate for the wind load.
4. Pack sill to level where required. Packer on top of sarking.
5. Sill flashing drains to outside.
6. Sarking.

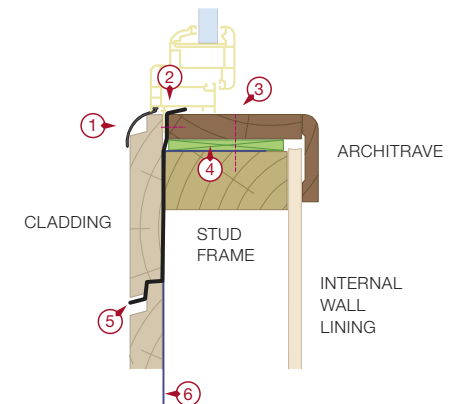

SINGLE SKIN VENEER CONSTRUCTION

UPVC SLIDING DOOR INSTALLATION

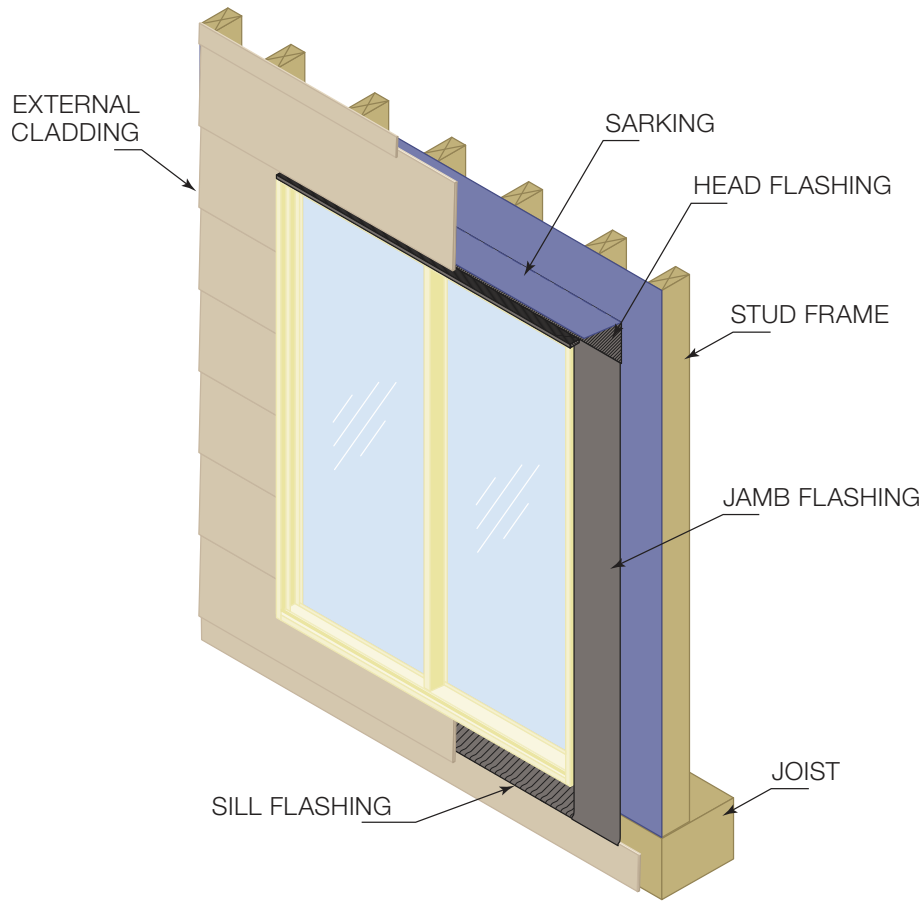

IMPORTANT

Ensure building loads do not bear on door.

Sill must be level side to side and front to back, and fully supported at all times.

SINGLE SKIN VENEER CONSTRUCTION

UPVC SLIDING DOOR INSTALLATION

Head

1. Sarking overlaps head flashing.
2. Pressed metal head flashing. Head flashing goes over jamb flashing and head and extends past window reveal by 150mm either side minimum.
3. Door head fitted to timber reveal.
4. Fix reveal to lintel with a fixing of a gauge and spacing appropriate for the wind load.

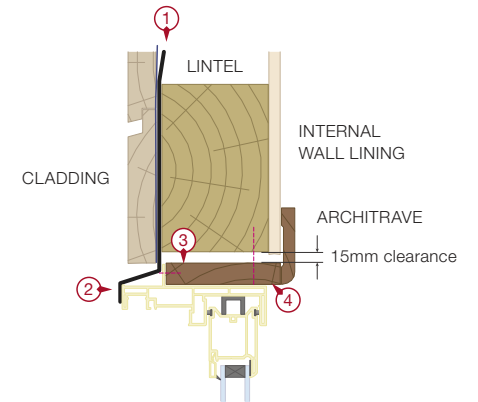

Jamb

1. Jamb flashing overlaps sarking.
2. Packer over sarking.
3. Fix reveal to studwork with a fixing of a gauge and spacing appropriate for the wind load.
4. Jamb flashing (mandatory) attached to the door and wall framing.
5. Sealant (external).

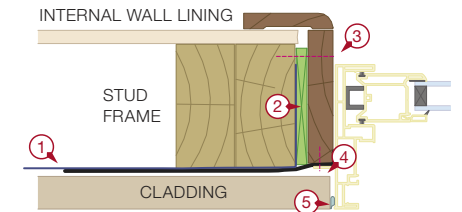

Sill

1. Sill supported.
2. Sealant over head of fixing. Fixing also set in sealant to reinsatate flashing.
3. Pack sill to level where required.
4. Angle trim sealed to structure and door sill (shown over flooring).
5. Sill flashing tray (mandatory) turned up and sealed at each end.

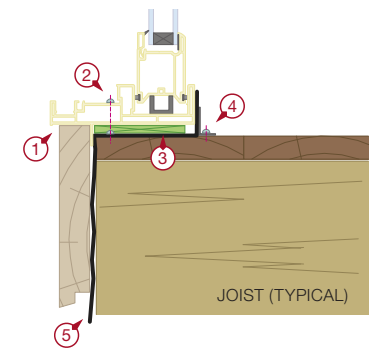

SINGLE SKIN VENEER CONSTRUCTION

TIMBER WINDOW INSTALLATION

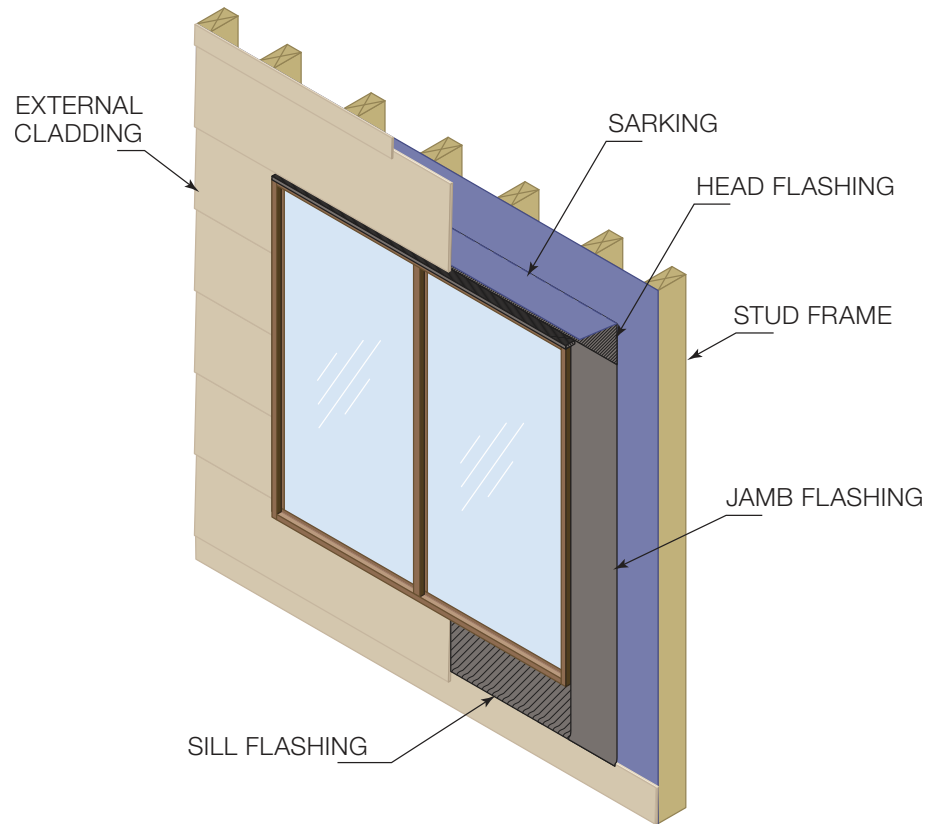

IMPORTANT

Ensure building loads do not bear on window.

Sill must be level side to side and front to back, and fully supported at all times.

SINGLE SKIN VENEER CONSTRUCTION

TIMBER WINDOW INSTALLATION

Head

1. Sarking overlaps head flashing.
2. Pressed metal head flashing. Head flashing goes over jamb flashing and head and extends past window reveal by 150mm either side minimum.
3. Fix window frame to lintel with a fixing of a gauge and spacing appropriate for the wind load.

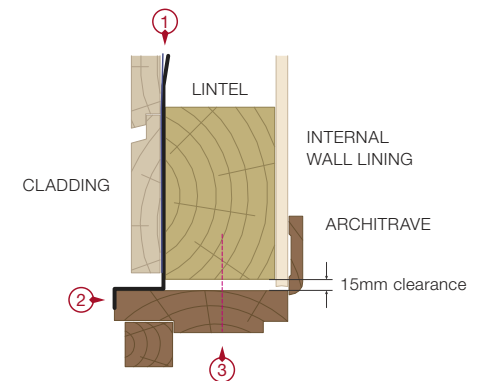

Jamb

1. Jamb flashing (mandatory) attached to the window and wall framing.
2. Packer over sarking.
3. Fix window to stud frame with a fixing of a gauge and spacing appropriate for the wind load.
4. Sealant (external).

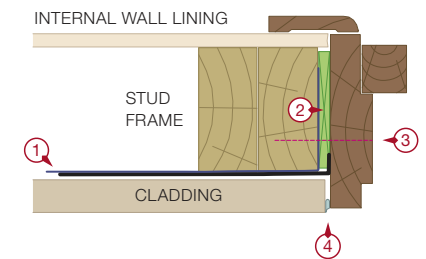

Sill

1. Sill supported.
2. Fix window to stud frame with a fixing of a gauge and spacing appropriate for the wind load.
3. Pack sill to level where required over sarking.
4. Flashing goes behind architrave.
5. Sarking.
6. Sill flashing tray (mandatory) overlaps sarking. Sill flashing drains to outside.

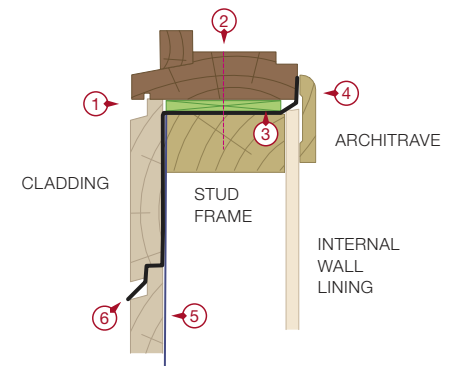

SINGLE SKIN VENEER CONSTRUCTION

TIMBER SLIDING DOOR INSTALLATION

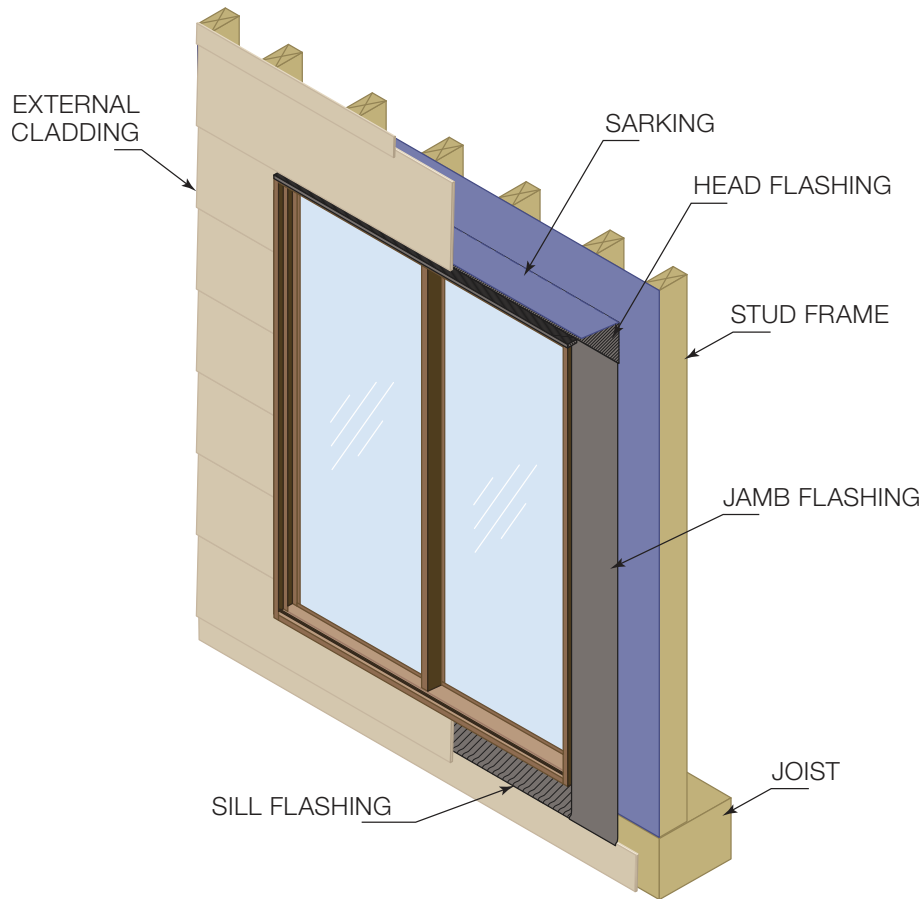

IMPORTANT

Ensure building loads do not bear on door.

Sill must be level side to side and front to back, and fully supported at all times.

SINGLE SKIN VENEER CONSTRUCTION

TIMBER SLIDING DOOR INSTALLATION

Head

1. Sarking overlaps head flashing.
2. Pressed metal head flashing. Head flashing goes over jamb flashing and head and extends past window reveal by 150mm either side minimum.
3. Fix door frame to lintel with a fixing of a gauge and spacing appropriate for the wind load.

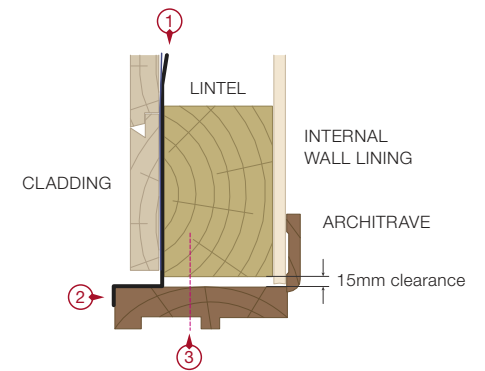

Jamb

1. Jamb flashing (mandatory) attached to the door and wall framing.
2. Packer over sarking.
3. Fix door frame to stud frame with a fixing of a gauge and spacing appropriate for the wind load.
4. Sealant (external).

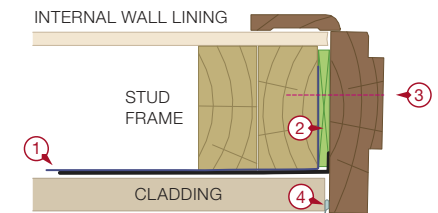

Sill

1. Sill supported.
2. Pack sill to level where required.
3. Sill flashing tray (mandatory) turned up and sealed at each end.

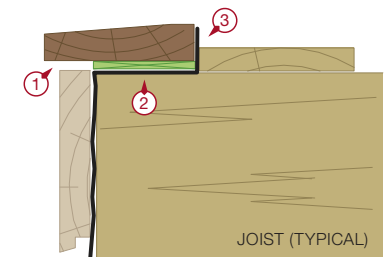

SOLID MASONRY CONSTRUCTION

ALUMINIUM WINDOW INSTALLATION

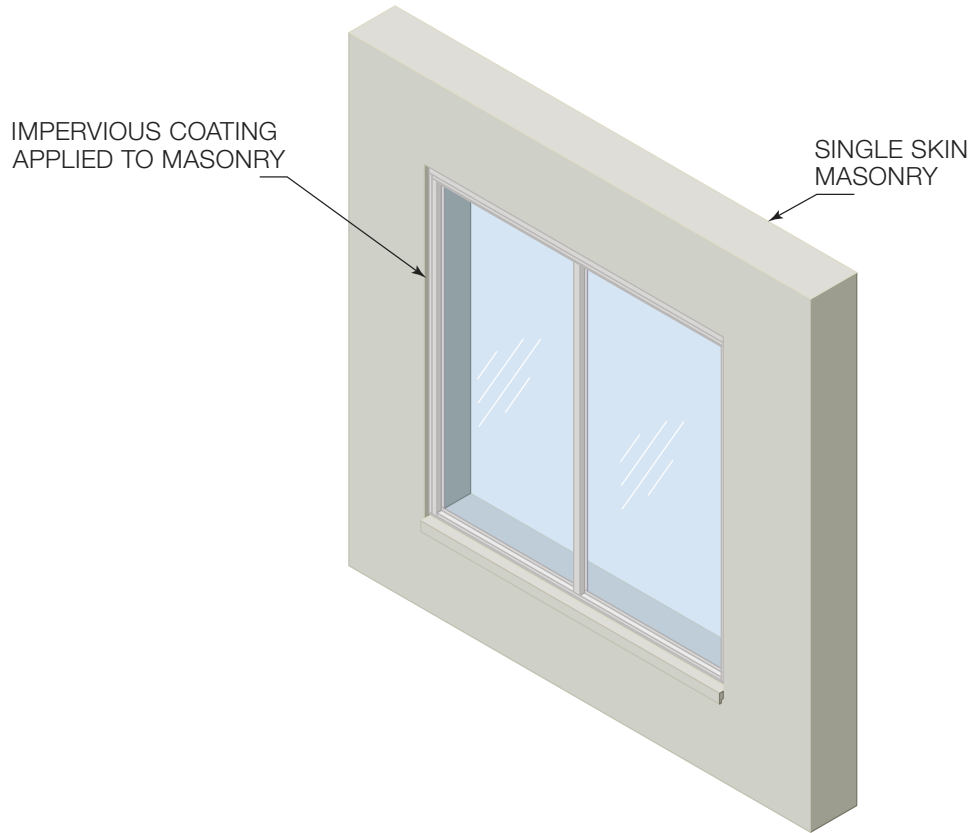

IMPORTANT

Ensure building loads do not bear on window.

Separate the Sill and outside brick skin with an isolating material to prevent possible reaction between blockwork/mortar and the aluminium framing. Contact can lead to extensive corrosion.

Sill must be level side to side and front to back, and fully supported at all times.

SOLID MASONRY CONSTRUCTION

ALUMINIUM WINDOW INSTALLATION

Head

1. Water-proof membrane applied to opening before fixing window.
2. Fix window with a fixing of a gauge and spacing appropriate for the wind load (use masonry plugs).
3. Angle trim sealed to structure and window (interior and exterior).

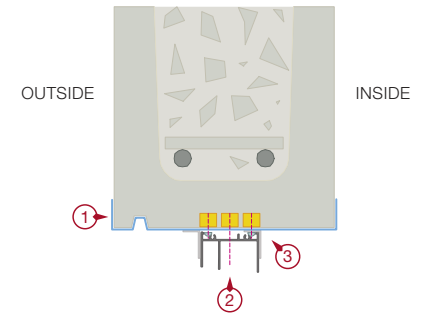

Jamb

1. Water-proof membrane applied to opening before fixing window.
2. Fix window with a fixing of a gauge and spacing appropriate for the wind load (use masonry plugs).
3. Angle trim sealed to structure and window.

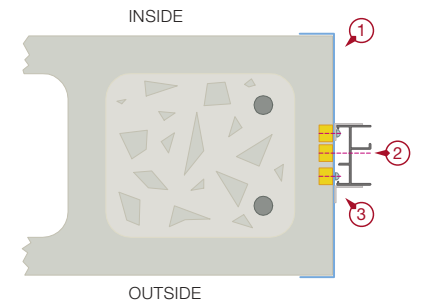

Sill

1. Water-proof membrane applied to opening before fixing window.
2. Do not block drainage holes (with render or tiles for example).
3. Angle trim sealed to structure and window.



SOLID MASONRY CONSTRUCTION

ALUMINIUM SLIDING DOOR INSTALLATION

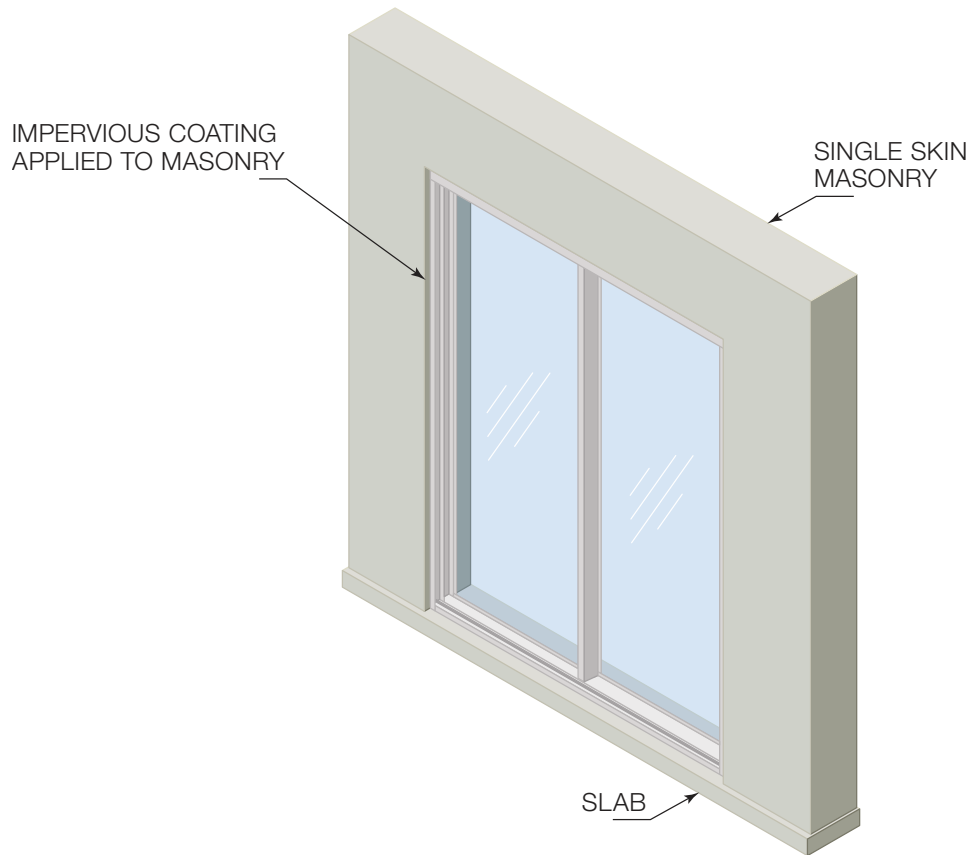

IMPORTANT

Ensure building loads do not bear on door.

Separate the Sill and outside brick skin with an isolating material to prevent possible reaction between blockwork/mortar and the aluminium framing. Contact can lead to extensive corrosion.

Sill must be level side to side and front to back, and fully supported at all times.

SOLID MASONRY CONSTRUCTION

ALUMINIUM SLIDING DOOR INSTALLATION

Head

1. Water-proof membrane applied to opening before fixing door.
2. Fix door with a fixing of a gauge and spacing appropriate for the wind load (use masonry plugs).
3. Angle trim sealed to structure and door (interior and exterior).

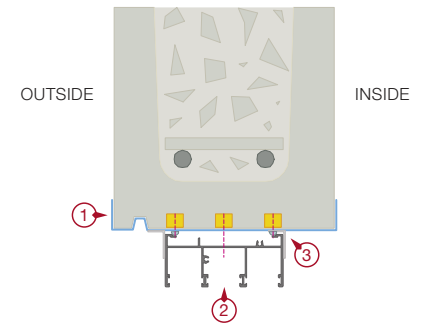

Jamb

4. Water-proof membrane applied to opening before fixing door.
5. Fix door with a fixing of a gauge and spacing appropriate for the wind load (use masonry plugs).
6. Angle trim sealed to structure and door (interior and exterior).

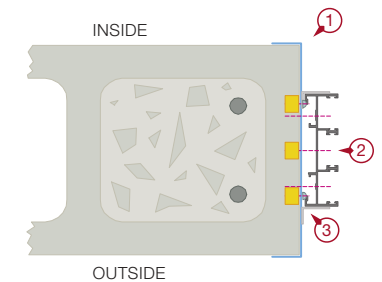

Sill

1. Sill flashing tray (mandatory).
2. Do not block drainage holes (with render or tiles for example).
3. Sealant over head of fixings. Fixings also set in sealant to waterproofing membrane.
4. Inside of door frame caulked to sill rebate and flashing tray.
5. Rebate in edge of concrete slab
6. Water-proof membrane applied to opening before fixing door.

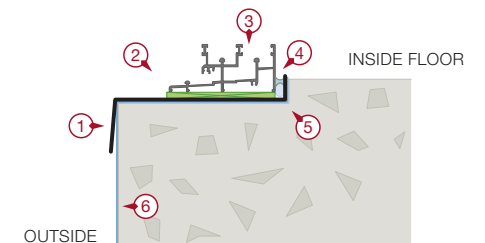

SOLID MASONRY CONSTRUCTION

UPVC WINDOW INSTALLATION

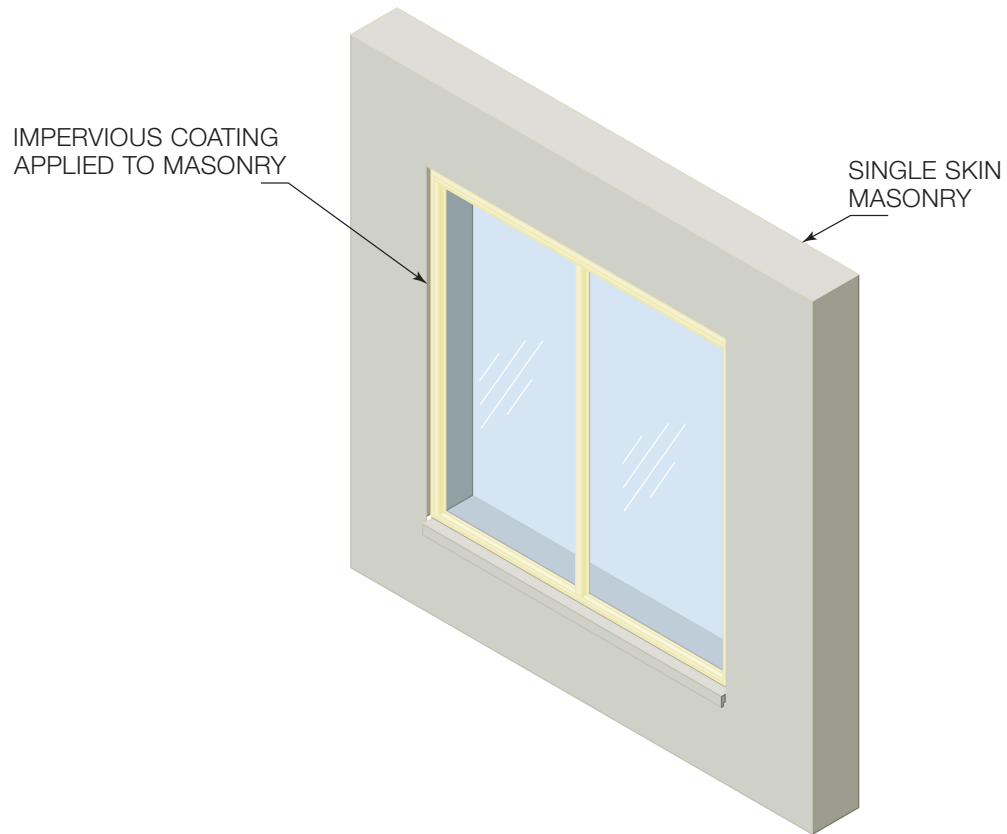

IMPORTANT

Ensure building loads do not bear on window.

Sill must be level side to side and front to back, and fully supported at all times.

SOLID MASONRY CONSTRUCTION

UPVC WINDOW INSTALLATION

Head

1. Water-proof membrane applied to opening before fixing window.
2. Fix window with a fixing of a gauge and spacing appropriate for the wind load. Use masonry plugs.
3. Angle trim sealed to structure and window (both interior and exterior).

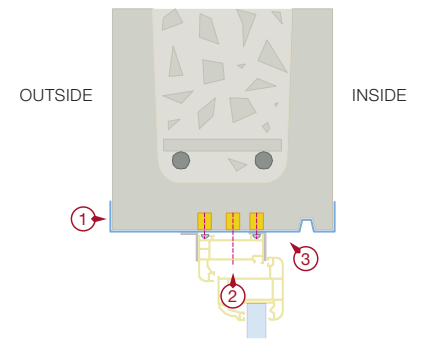

Jamb

1. Water-proof membrane applied to opening before fixing window.
2. Fix window with a fixing of a gauge and spacing appropriate for the wind load (use masonry plugs).
3. Angle trim sealed to structure and window (both interior and exterior).

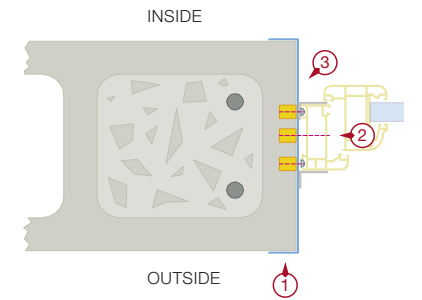

Sill

1. Water-proof membrane applied to opening before fixing window.
2. Do not block drainage holes (with render or tiles for example).
3. Sealant over head of fixings. Fixings also set in sealant to waterproofing membrane.
4. Angle trim sealed to structure and window (interior only).

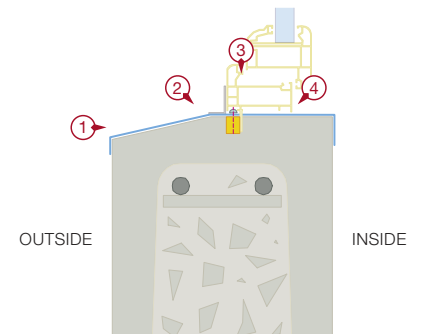

SOLID MASONRY CONSTRUCTION

UPVC SLIDING DOOR INSTALLATION

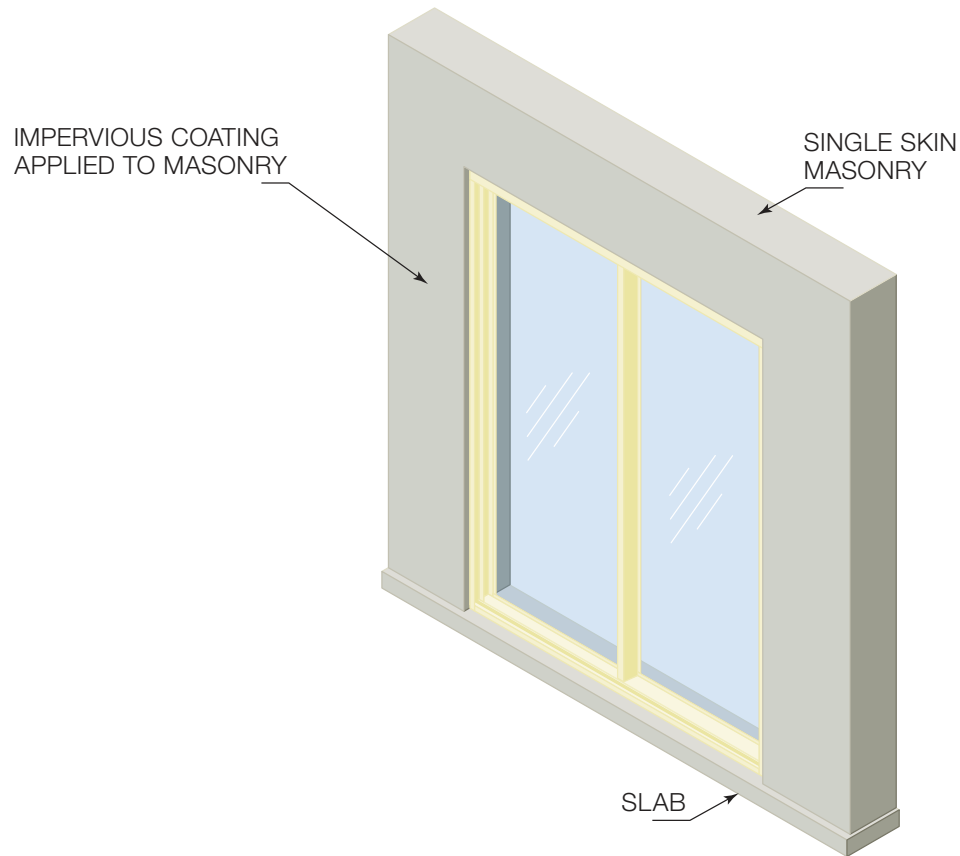

IMPORTANT

Ensure building loads do not bear on door.

Sill must be level side to side and front to back, and fully supported at all times.

SOLID MASONRY CONSTRUCTION

UPVC SLIDING DOOR INSTALLATION

Head

1. Water-proof membrane applied to opening before fixing door.
2. Fix door with a fixing of a gauge and spacing appropriate for the wind load. Use masonry plugs.
3. Angle trim sealed to structure and door (both interior and exterior).

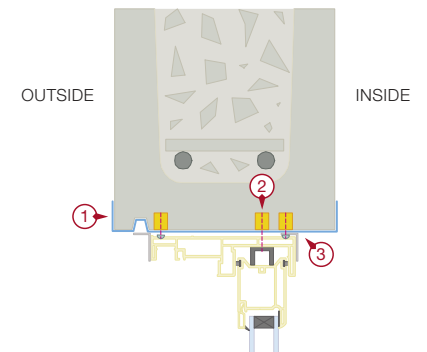

Jamb

1. Water-proof membrane applied to opening before fixing door.
2. Fix door with a fixing of a gauge and spacing appropriate for the wind load (use masonry plugs).
3. Angle trim sealed to structure and door.

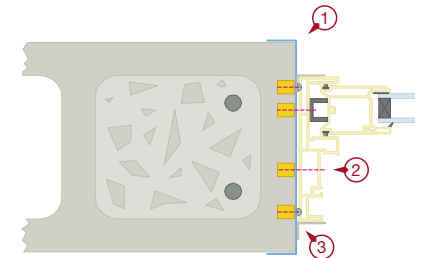

Sill

1. Sill flashing tray (mandatory).
2. Do not block drainage holes (with render or tiles for example).
3. Sealant over head of fixings. Fixings also set in sealant to waterproofing membrane.
4. Inside of door frame caulked to sill rebate and flashing tray.
5. Rebate in edge of concrete slab.
6. Water-proof membrane applied to opening before fixing door.

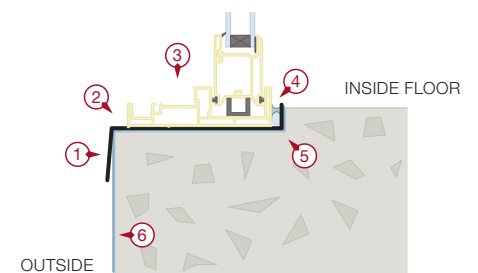

SOLID MASONRY CONSTRUCTION

TIMBER WINDOW INSTALLATION

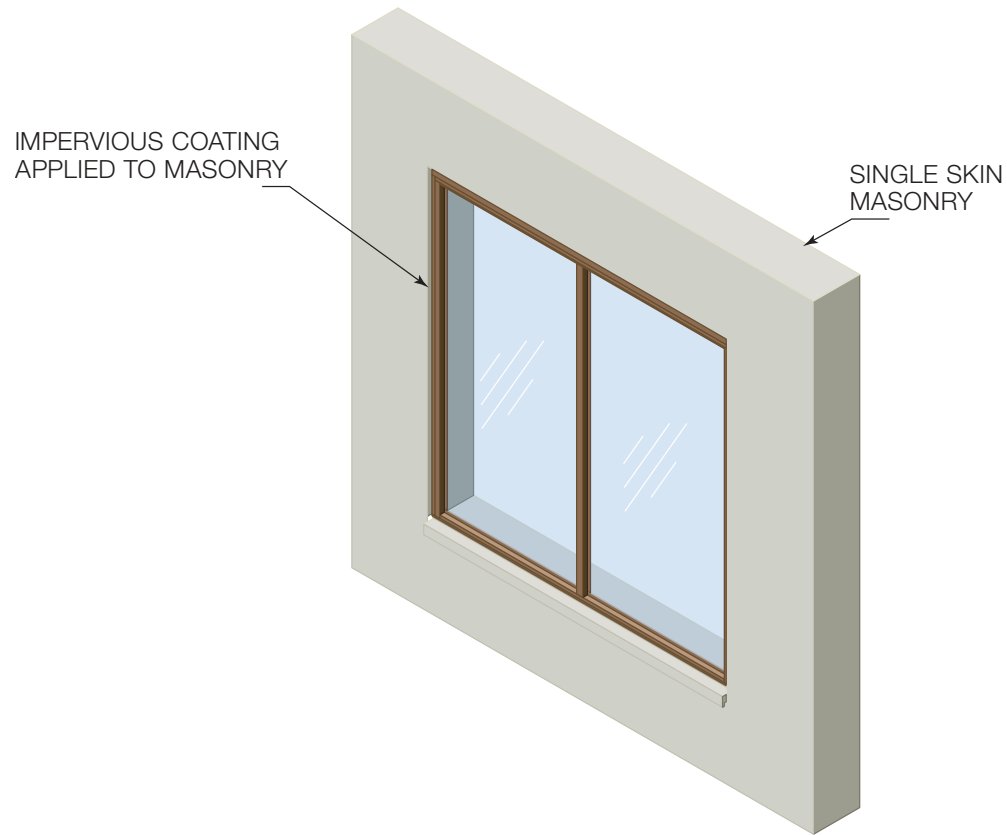

IMPORTANT

Ensure building loads do not bear on window.

Sill must be level side to side and front to back, and fully supported at all times.

SOLID MASONRY CONSTRUCTION

TIMBER WINDOW INSTALLATION

Head

1. Water-proof membrane applied to opening before fixing window.
2. Sealant (exterior).
3. Fix window with a fixing of a gauge and spacing appropriate for the wind load. Use masonry plugs.
4. Adhesive applied between head and masonry.
5. Sealant (interior).

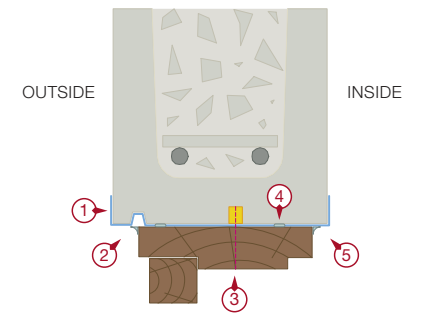

Jamb

1. Water-proof membrane applied to opening before fixing window.
2. Sealant (interior).
3. Fix window with a fixing of a gauge and spacing appropriate for the wind load (use masonry plugs).
4. Adhesive applied between jamb and masonry.
5. Sealant (exterior).

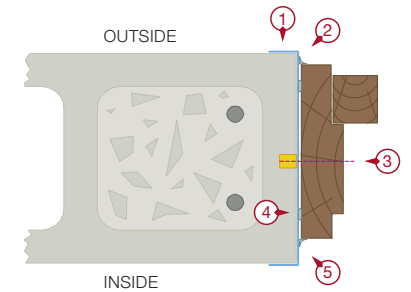

Sill

1. Water-proof membrane applied to opening before fixing window.
2. Do not block drainage holes (with render or tiles for example).
3. Sealant over head of fixings. Fixings also set in sealant to waterproofing membrane.
4. Angle trim sealed to structure and window.
5. Masonry plugs.

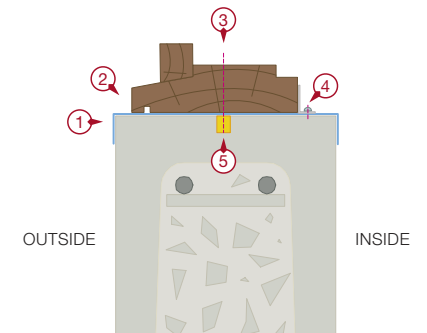

SOLID MASONRY CONSTRUCTION

TIMBER SLIDING DOOR INSTALLATION

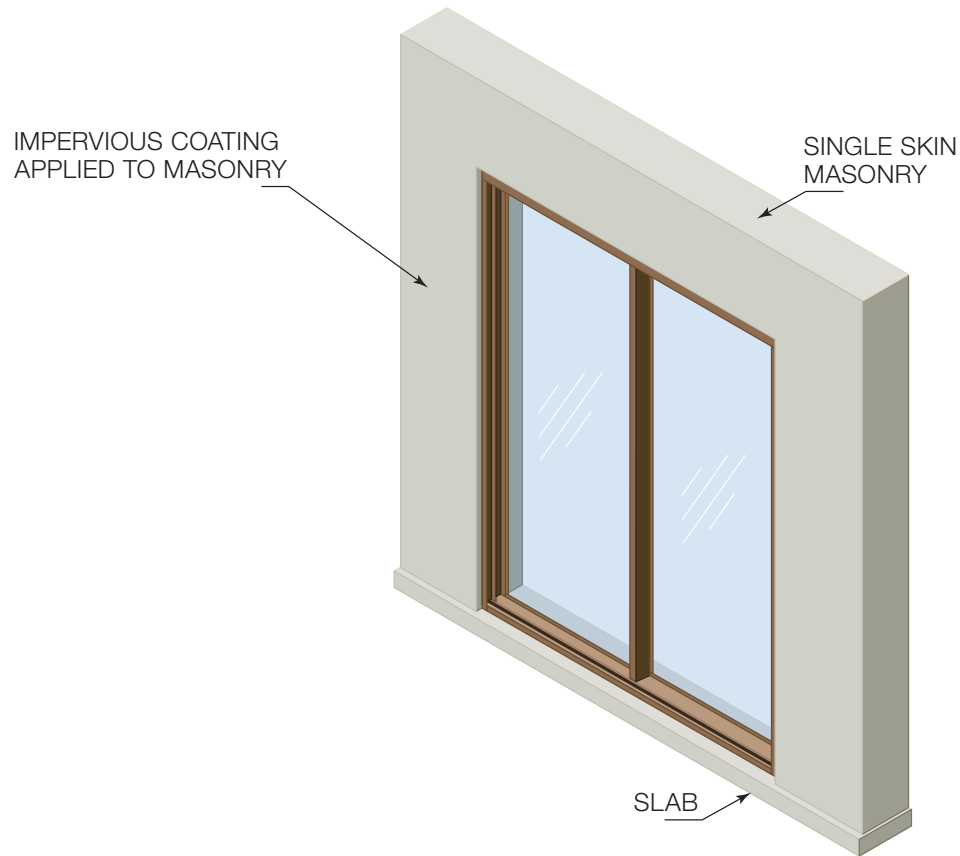

IMPORTANT

Ensure building loads do not bear on door.

Sill must be level side to side and front to back, and fully supported at all times.

SOLID MASONRY CONSTRUCTION

TIMBER SLIDING DOOR INSTALLATION

Head

1. Water-proof membrane applied to opening before fixing door.
2. Sealant (interior).
3. Fix door with a fixing of a gauge and spacing appropriate for the wind load. Use masonry plugs.
4. Sealant (exterior).

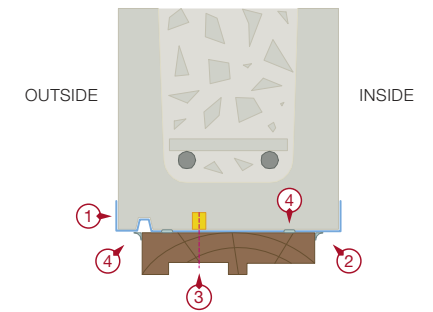

Jamb

1. Water-proof membrane applied to opening before fixing door.
2. Sealant (interior).
3. Fix door with a fixing of a gauge and spacing appropriate for the wind load (use masonry plugs).
4. Adhesive applied between jamb and masonry.
5. Sealant (exterior).

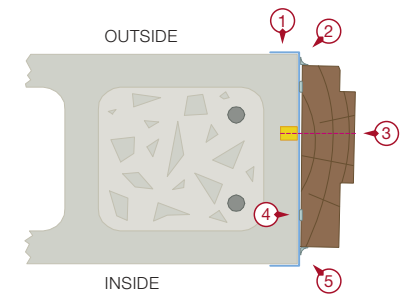

Sill

1. Sill flashing tray (mandatory).
2. Water-proof membrane applied to opening before fixing door.
3. Inside of door frame caulked to sill rebate and flashing tray.
4. Rebate in edge of concrete slab.

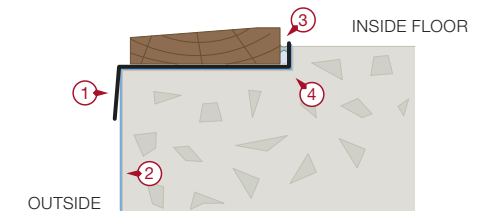

AGWA GUIDE SERIES

Fixing



Energy Efficiency



Bushfire Areas



Glass & Glazing



Window & Door Selection

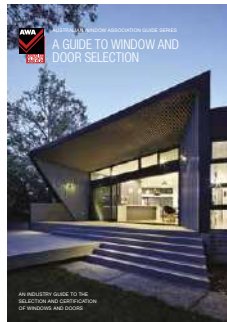

Download other guides in this series from www.agwa.com.au



AUSTRALIAN
GLASS & WINDOW
ASSOCIATION

Document No. AGWA2018/INSV3

Copyright © 2018 Australian Glass and Window Association. All Rights Reserved.

a: Pymble Corporate Centre, Suite 1, Level 1, Building 1, 20 Bridge Street, Pymble NSW 2073

t: +61 2 9498 2768 f: +61 2 9498 3816 e: info@agwa.com.au w: www.agwa.com.au